

# Next-generation mobile WiMAX– IEEE 802.16m

**Jong-Kae (JK) Fwu**

[jong-kae.fwu@intel.com](mailto:jong-kae.fwu@intel.com)

Vice Chair, IEEE 802.16 WG, TGm  
Wireless Standards and Technology  
Intel Architecture Group/Mobile Wireless Group

December, 14 2009



# Outline

- Introduction, Motivations and overview
- IEEE 802.16m Technology Overview
- IEEE 802.16m Technology Details
  - Frame Structure
  - Symbol Structure, Subchannelization and pilot pattern
  - DL Sync Channel (Advanced Preamble)
  - DL & UL Control Channels (PHY design)
  - Network Entry PHY Stages
  - DL/UL MIMO
  - Coding and HARQ

# Introduction – 802.16m

- WiMAX stands for “Worldwide Interoperability for Microwave Access”.
- Mobile WiMAX: Rel 1.0 (802.16e) → Rel 1.5 → Rel 2.0 (802.16m)
- IEEE 802.16 Task Group m (TGm) is chartered to develop an amendment (802.16m) which provides performance improvements necessary to support future advanced services and applications.
- Meet/Exceed IMT-Advanced requirements for next generation mobile networks with legacy support for WirelessMAN-OFDMA equipments.
- IEEE 802.16m spec is currently at letter ballot stage and was submitted as IEEE 802.16 IMT-Advanced candidate to the ITU-R.

## Mobile WiMAX Roadmap

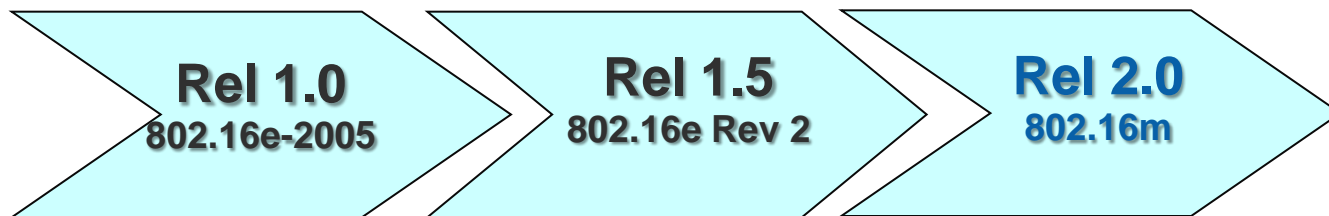

# Why do 802.16m?

- Provide continuity to the first release of Mobile WiMAX (802.16e) and offer evolution path to existing WiMAX operators and win new operators targeting 2012+ deployments
- Improve system performance
  - New technology ingredients over 16e
  - Significantly increase performance lead over HSPA/HSPA+ and LTE
  - Reduce overall system overhead and design complexity
  - Enable more flexible radio network architectures

# IEEE 802.16m Status Overview

- Stage-1: System Requirements Document (SRD)
  - [http://ieee802.org/16/tgm/docs/80216m-07\\_002r9.pdf](http://ieee802.org/16/tgm/docs/80216m-07_002r9.pdf)
- Stage-2: System Description Document (SDD)
  - [http://ieee802.org/16/tgm/docs/80216m-09\\_0034r2.zip](http://ieee802.org/16/tgm/docs/80216m-09_0034r2.zip)
- Stage-3: 802.16m Amendment Working Document (AWD)
  - [http://ieee802.org/16/tgm/docs/80216m-09\\_0010r2.zip](http://ieee802.org/16/tgm/docs/80216m-09_0010r2.zip)
- Letter Ballot : (Working Group and EC review)
  - *IEEE 802.16m Draft Standards Draft 1 - 07/09*
  - *IEEE 802.16m Draft Standards Draft 2 - 10/09*
  - *IEEE 802.16m Draft Standards Draft 3 - 12/09*
  - <http://ieee802.org/16/pubs/80216m.html>
- Sponsor Ballot: (EC review & standard board approval)
  - *To start at 1st half of 2010,*
  - *To be completed and published at 2<sup>nd</sup> half of 2010*

# 802.16m Technology Overview

- Fully backwards compatibility with 802.16e
- Multi-User MIMO for higher system capacity
- Advanced Interference Mitigation Techniques, e.g. Multi-BS MIMO, Fractional Freq Reuse, etc.
- Reduced Air interface one-way latency  $< 10\text{ms}$  and handover latency  $< 30\text{ms}$
- Improved Voice support with lesser MAC overhead and more capacity
- Integrated relay capability and femto-cell support
- Improved support for LBS and MBS services
- Support for self-organizing networks



# Frame Structure

# 802.16m Frame Structure

- Super frame – 20 ms
  - Periodicity of PA-Preamble and SFH
- Frame – 5 ms

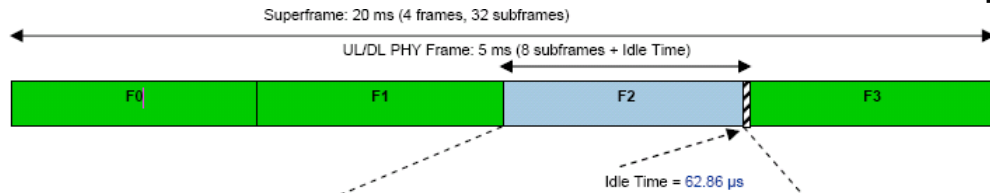

- Includes 1 preamble symbol and 1 DL→UL transition in TDD
- Includes 8 (or 7/6/5) subframes

- Subframe – 6 or 5 (or 7/9) OFDM Symbols

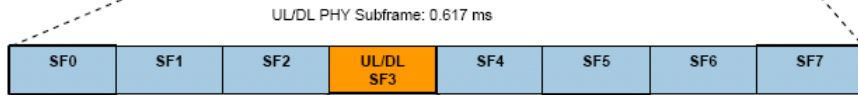

- Slot duration
- Pilot periodicity
- Time unit for allocations
- A-MAPs are transmitted on each subframe

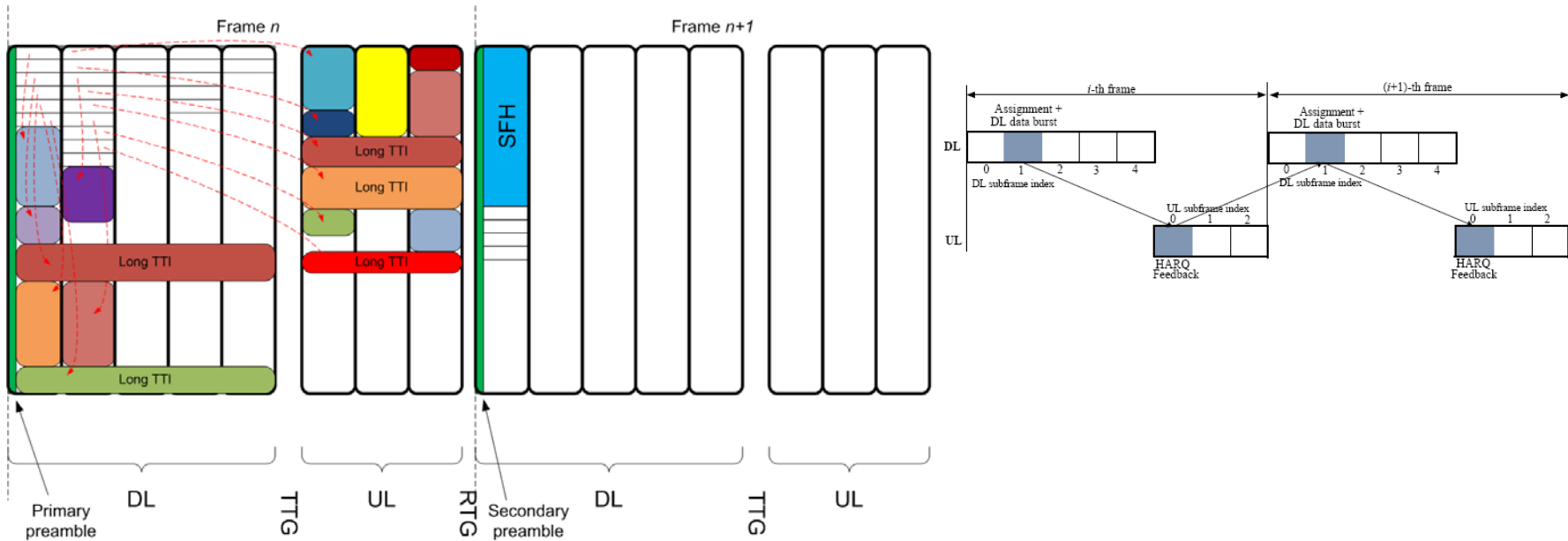

Figure 18 Frame structure with type-1 subframe in FDD duplex mode (CP=1/8 T<sub>u</sub>)

- Frame structures support:
  - CP=1/8, 1/16, 1/4
  - TDD, FDD (and H-FDD as special case)
  - Different subcarrier spacing for 7, 8.75 MHz may be used.



# Burst shape and maps relevance



- Bursts allocation is 1-Dimensional – occupies integer number of LRUs in frequency domain – Long or Short TTI
  - Short TTI – burst is contained in 1 subframe
  - Long TTI – burst occupies all of the DL or UL subframes
- A-MAP is present on every DL subframe, and describes:
  - DL bursts starting in this subframe
  - UL bursts starting 4 subframes later (with some exceptions)
- HARQ retransmission is possible after one frame as shown above

# Mixed mode frame structure

- AAI DL subframes are TDM-ed with legacy DL as a new zone (ignored by legacy MS)
- AAI UL can be TDM-ed or FDM-ed with legacy UL PUSC

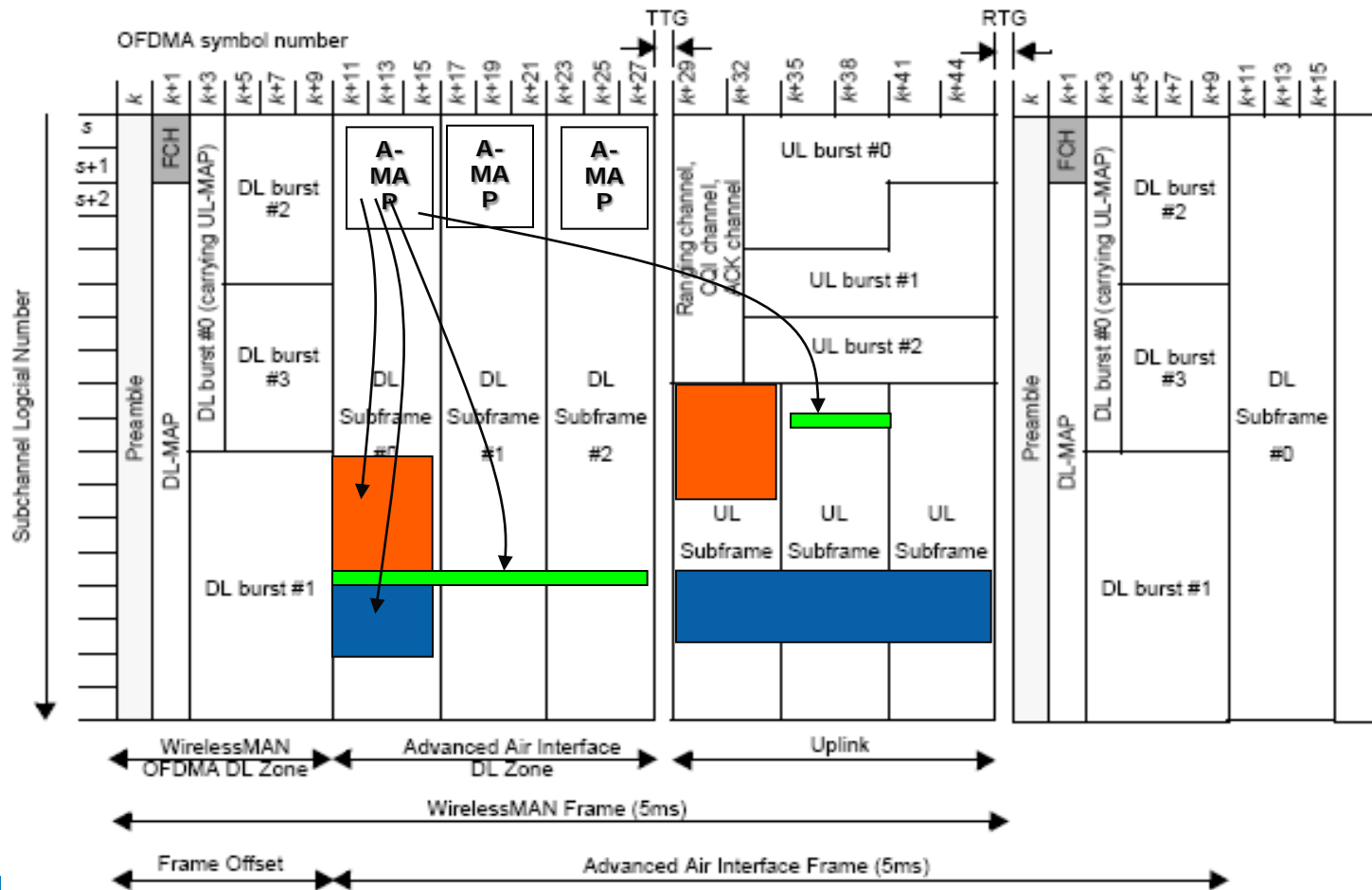

# DL/UL Symbol Structure

# 802.16m Downlink Physical Structure

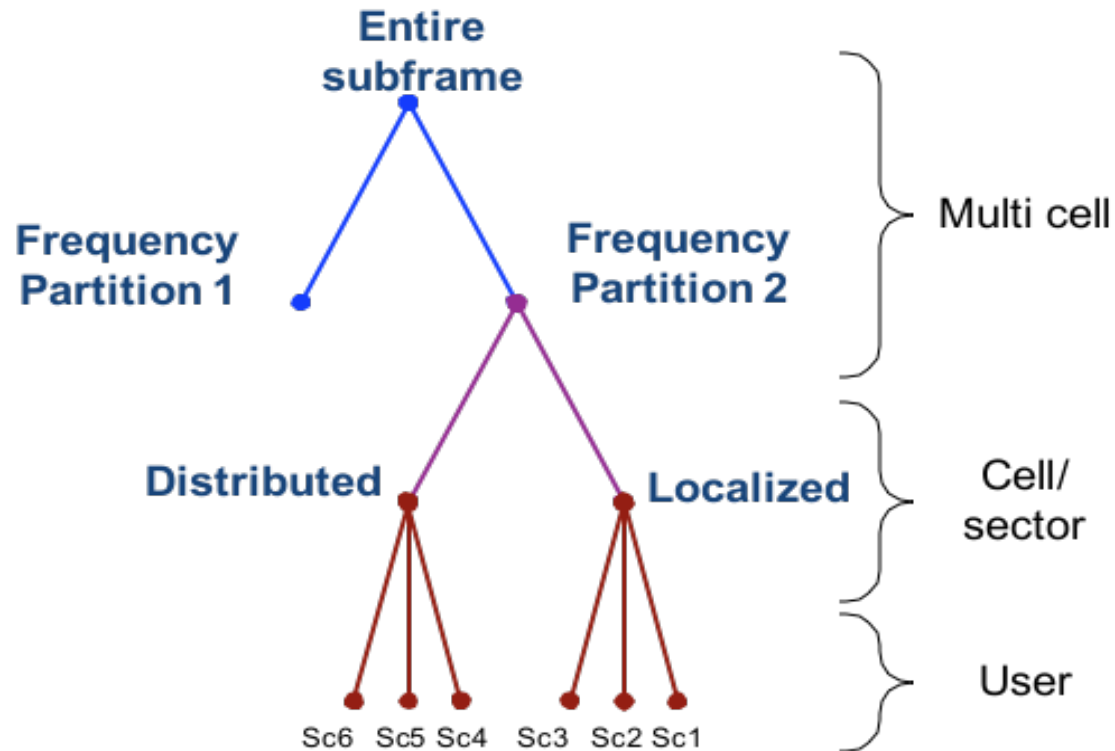

# 802.16m DL Symbol Structure (Abst)

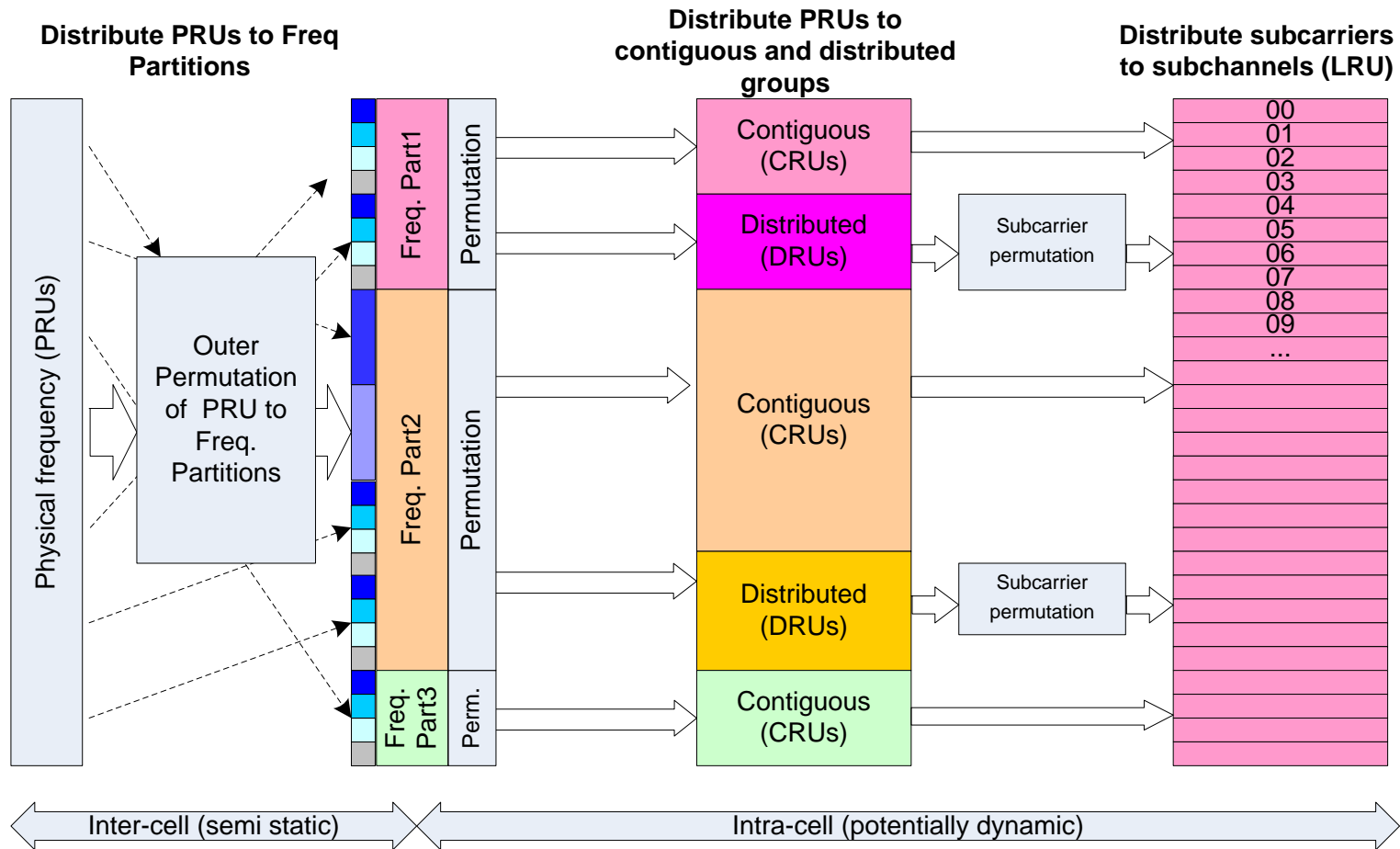

# Subchannelization/Permutation

- Concurrent distributed and localized transmissions in the subframe:
  - UL/DL DRU: tiles/tone-pair permutation (~UL/DL PUSC)
  - Subband CRU: localized resource w. band selection (~band AMC)
  - Miniband CRU: diversity resource w. dedicated pilots
- Concurrent reuse-1 and “soft” reuse-3 (FFR)
  - Up to 4 frequency partitions: 1 reuse-1 and 3 reuse-3
  - Low power transmission is allowed on other segments’ reuse-3 frequency partitions
- Resource units are divided among the various usages

48 Physical Resource Units

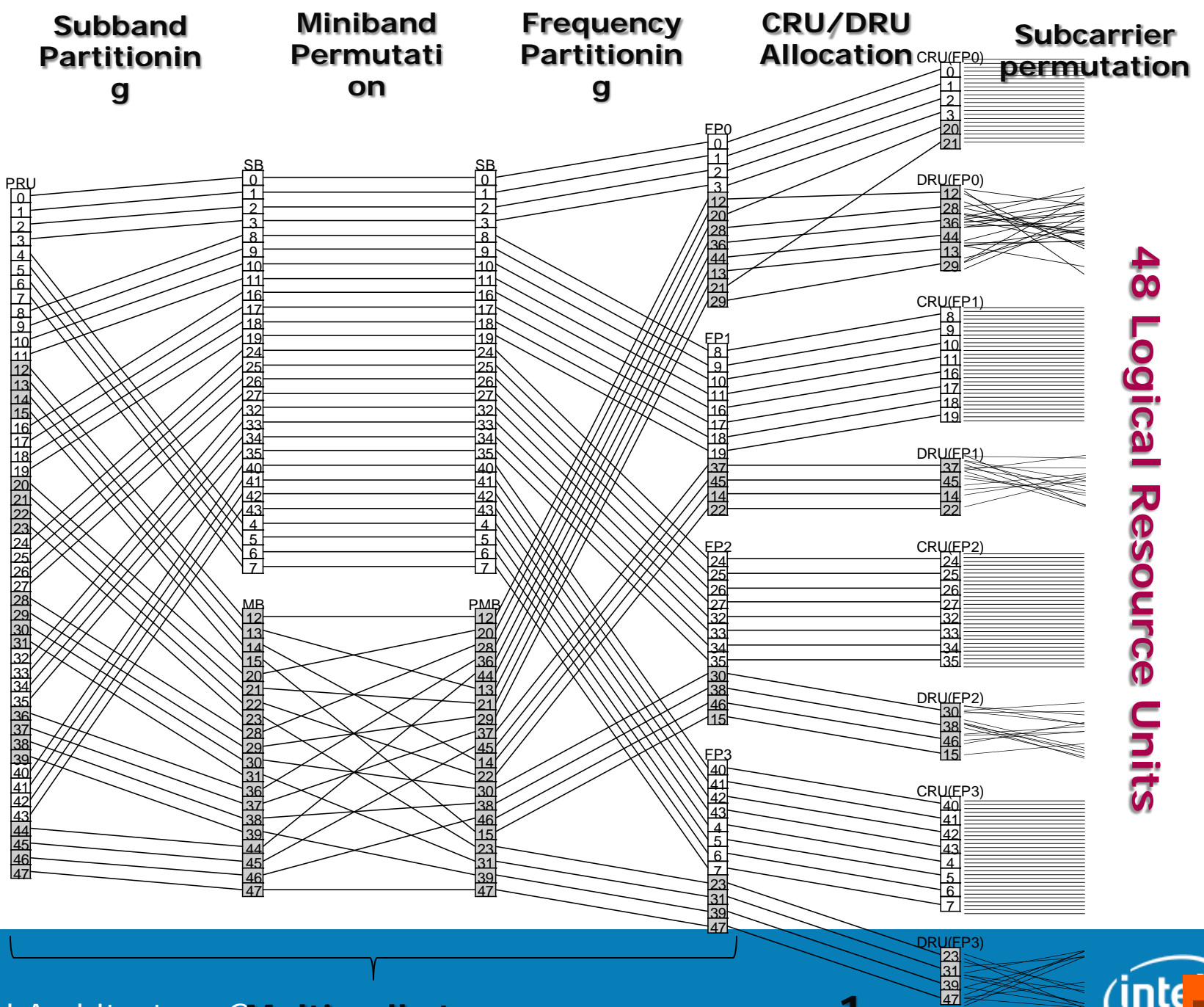

48 Logical Resource Units



# Pilot patterns

- Dedicated precoded pilots are used
- Shared pilots for DL DRU, always two streams
- Pilots density is adapted to number of streams
  - 5.6% pilot overhead per stream for DL 1 or 2 streams
  - 3.7% per stream for 3 or 4 streams
- Interlaced pilots (pilots collides with data) are used to exploit pilot boosting gain

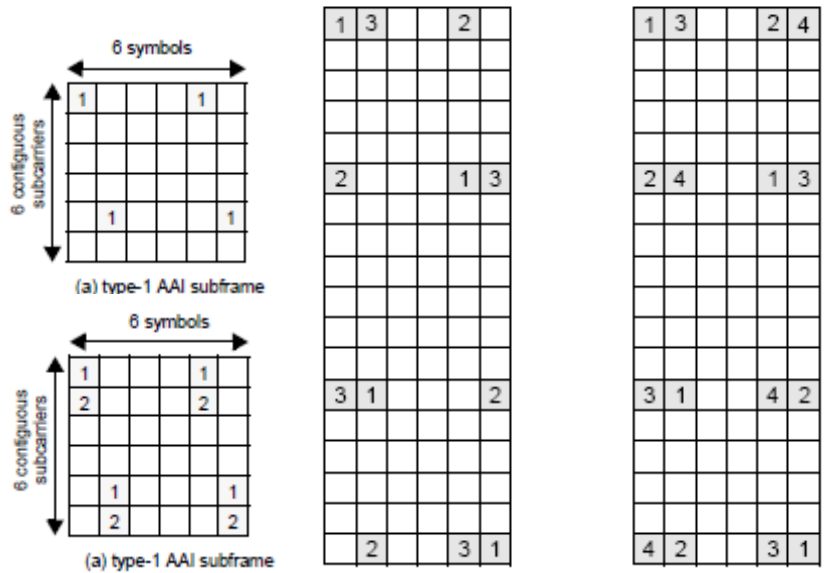
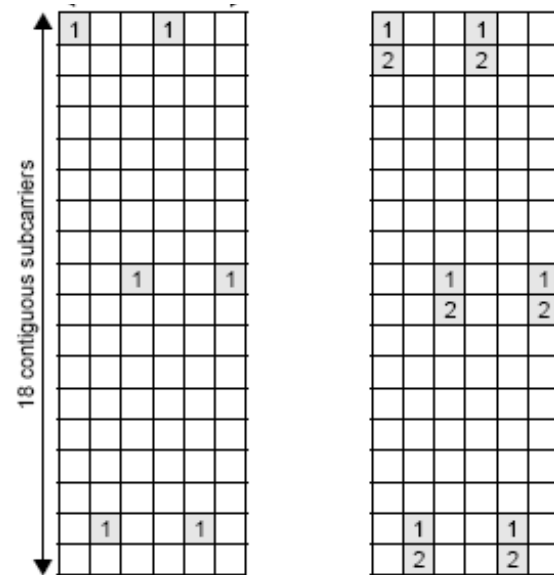



# 802.16m Pilot Interlacing

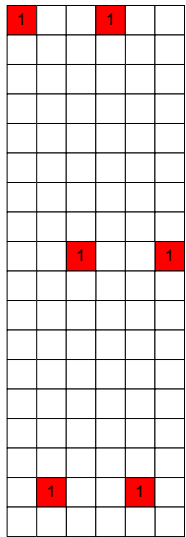

Pilot #0

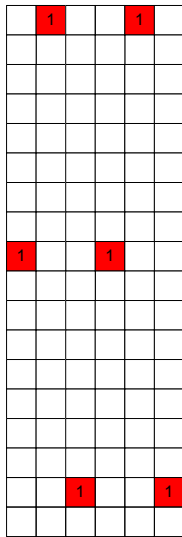

Pilot #1

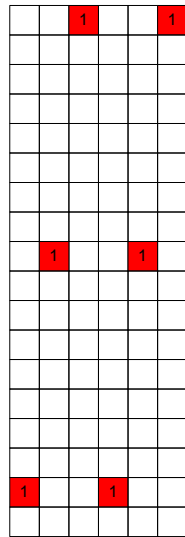

Pilot #2

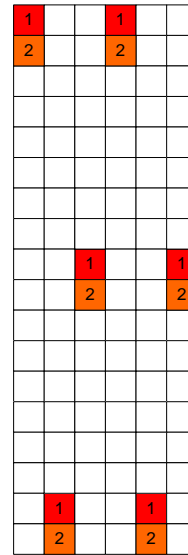

Pilot #0

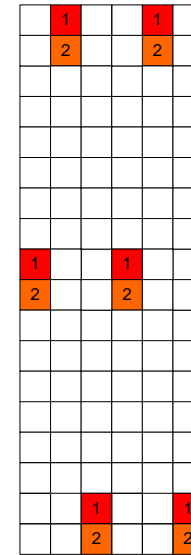

Pilot #1

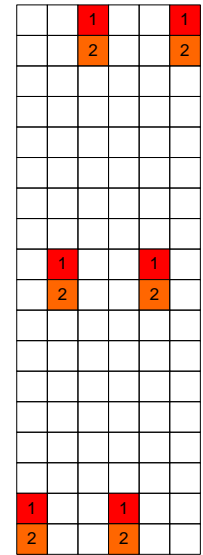

Pilot #2

**Single Stream Interlaced Pilots**

**2 Stream Interlaced Pilots**



# Advanced Preamble (A-Preamble)

# DL Sync Channel - Preamble

- Hierarchical Structure
- Primary Advanced Preamble
  - One symbol per superframe
  - Super frame synchronization
  - Initial acquisition (timing/carrier recovery)
- Secondary Advanced Preamble
  - Three symbols per superframe
  - Fine synchronization and cell identification

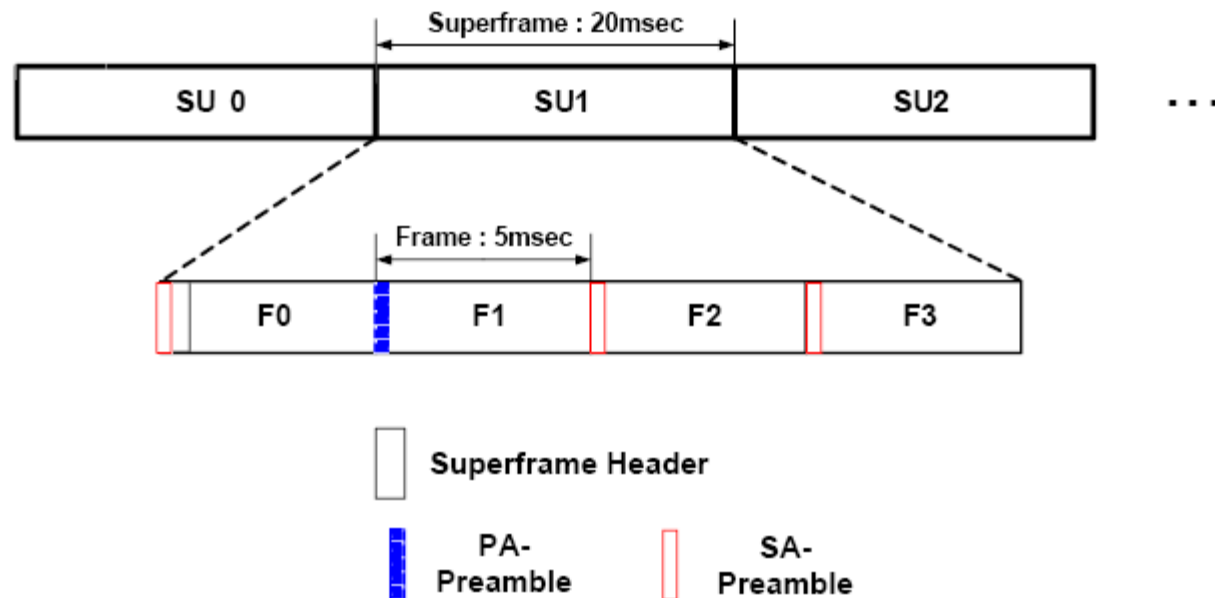

# PA-Preamble

- Fixed BW (5 MHz), Reuse 1 and 216 sequence length
- 11 binary sequences
- Primary Preamble – $N_{FFT}$ , initial acquisition, frequency & timing estimation and carrier scanning
- Every other subcarrier is null (2x repetition in time)
- Carries BW information
  - Index 0 : 5MHz, Index 1 : 7, 8.75, 10 MHz
  - Index 2 : 20 MHz
  - Indices 3~9 : reserved
  - Index 10 : Partially configured carrier

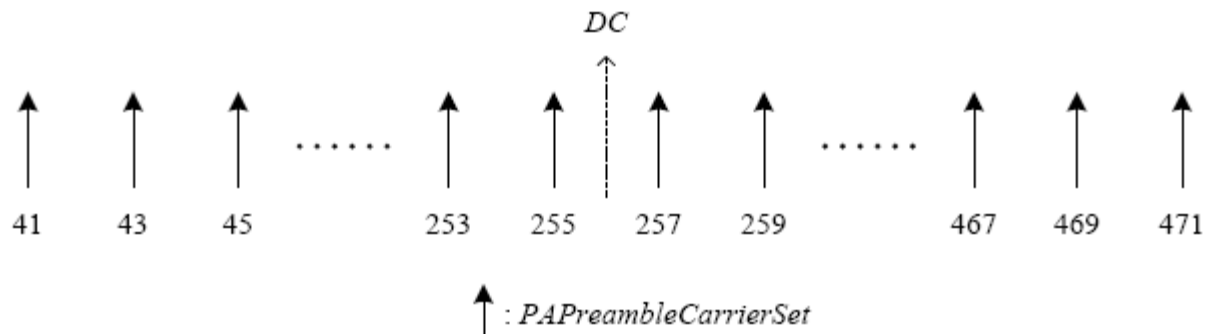

# SA-Preamble

- Carries 768 cell IDs: 3x256
- QPSK
- Frequency reuse 3 (one third of the subcarriers)
- Scalable structure
  - Support multiple BW - 5 MHz (8 subblocks) and extend to 10/20 MHz
  - Support Tone dropping for irregular BW
  - Support multiple Tx antenna (divided to blocks for different antennas)
- Block cyclic shift avoid the ambiguity of legacy preamble detection
- SA-Preamble:
  - Used for cell selection and RSSI/CINR measurements.
  - Different size for different BW.
  - Sequence depends on the segment (3 different segments).

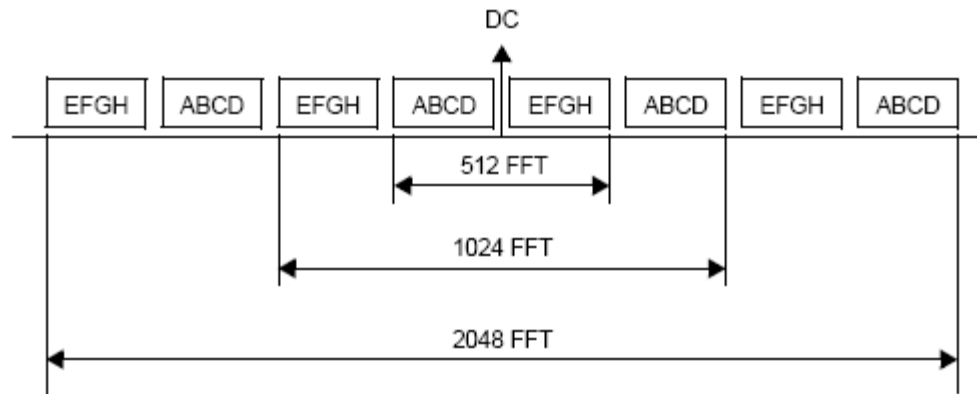

# DL/UL Control Channels

# DL control channels overview

- Super Frame Header (P-SFH & S-SFH)
  - Transmitted/ broadcasts every superframe (20 ms)
  - SFH carries essential system parameters and system configuration information. It's located in the first DL subframe of a superframe and is divided into primary SFH (P-SFH) and second SFH (S-SFH).
- A-MAP
  - Contains information for either unicast or broadcast traffic control.
  - Transmitted every DL subframe (~600 us) and contains:
    - (UL) HARQ feedback (HF)
    - UL Power Control (PC)
    - Non User Specific – broadcasts the configuration of Unicast Control in current subframe + indexing information for HF and PC
    - Unicast Control – IEs that describe DL and UL assignments

# SFH Physical Structure (1)

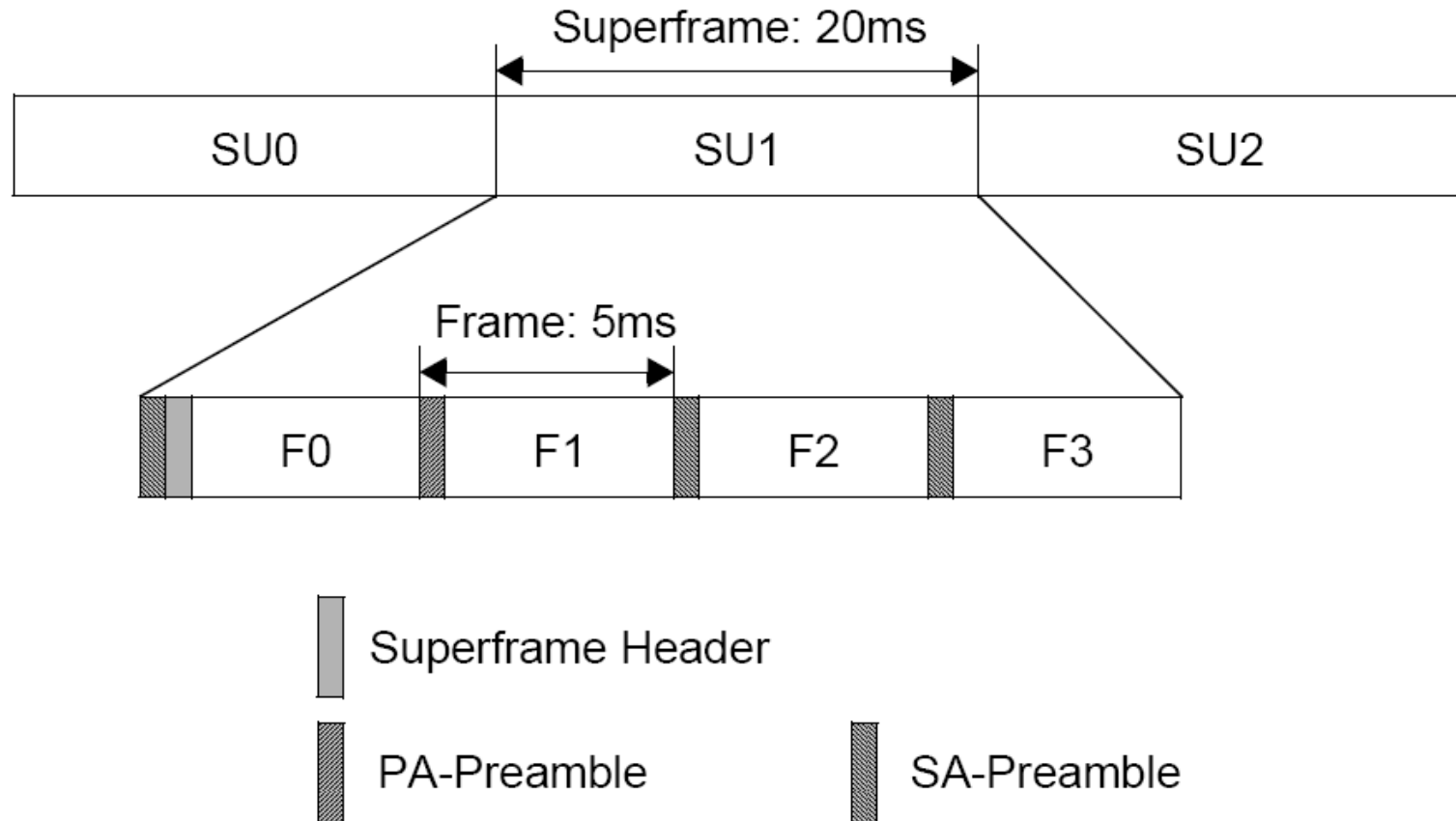



# SFH Physical Structure (2)

- Transmitted in the beginning of the 1<sup>st</sup> sub-frame of the super frame, fixed permutation (1 freq partition, all DRU)
- Contains P-SFH and/or S-SFH
  - Primary super frame header (P-SFH):
    - Always transmitted every superframe and occupies the first few DLRUs of the subframe.
    - Defines repetition of secondary SFH
    - 3 bytes, TBCC, QPSK with effective code rate of 1/24 using ¼ TBCC as the mother code.
  - Secondary super frame header (S-SFH):
    - S-SFH takes DLRUs after P-SFH and has a variable size, depending on the MCS and S-SFH subpacket to be transmitted
    - Consists of 3 types of subpackets. Each optimized for different activity.
    - SP1 optimized for NW re-entry, SP2 optimized for initial NW entry and NW discovery and SP3 contains remaining information.
    - ~20 bytes (limited to 15 LRUs), TBCC, QPSK with optional code rates of: 1/4 , 1/8, 1/12 or 1/16.



# A-MAP Region Location and Structure

A-MAP	A-MAP	A-MAP	A-MAP				
DL SF0	DL SF1	DL SF2	DL SF3	UL SF4	UL SF5	UL SF6	UL SF7

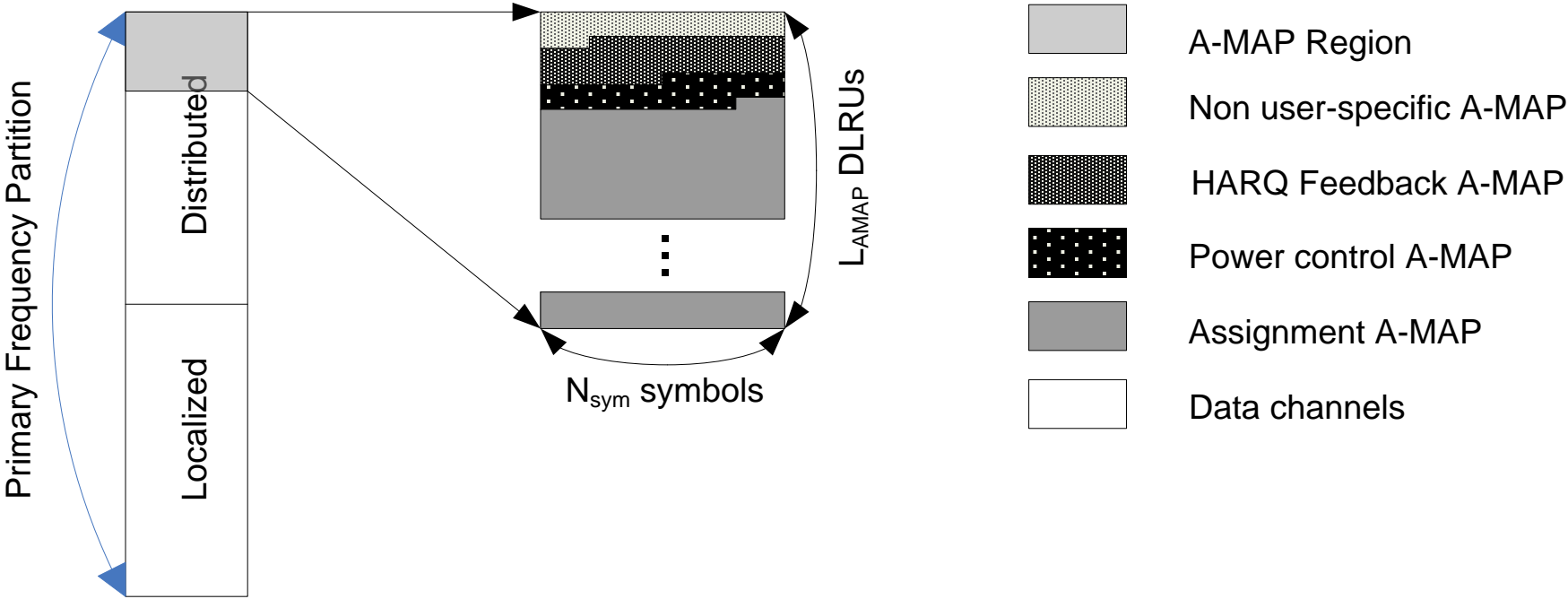

# DL Control Channels - A-MAP

- A-MAP stands for the DL control channels at each subframe. It includes:
  - Non-user-specific information to decode the rest of the A-MAP
    - Code rate, # of Assignment A-MAPs, etc
  - UL HARQ Feedback (N/ACK)
  - Closed-loop power control commands
  - Unicast control IEs – describe DL and UL allocations in User-Specific Information Elements:
    - Basic DL/UL assignment
    - Subband Assignment, Persistent allocation (PA), Group resource allocation (GRA), Composite PA ...
- User-specific IEs are separately encoded
  - to allow different power boosting for each user according to its link adaptation
  - Each IE has 16 bits CRC which is masked with the target STation ID
  - IEs can be encoded with two code rates for reuse 1, rate=1/2 for reuse-3 frequency partitions

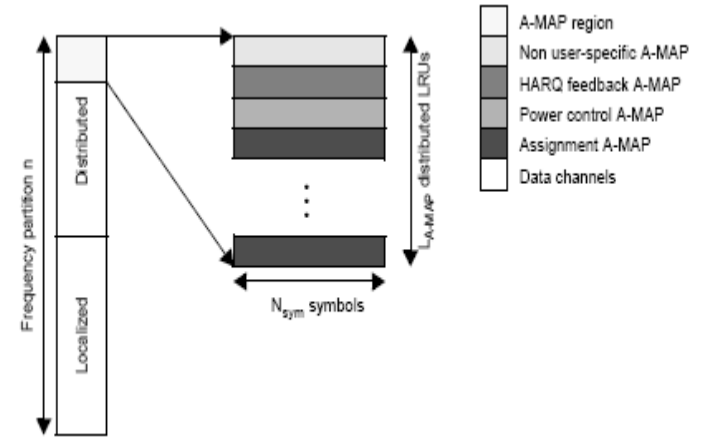

# UL control channels

- UL Fast Feedback Channel
  - Primary Fast feedback Channels
  - Secondary Fast feedback Channels
- HARQ ACK/NACK feedback
- BW request: support 3 & 5 step BW REQ
- Ranging: Non-synchronized and Synchronized ranging
- Sounding

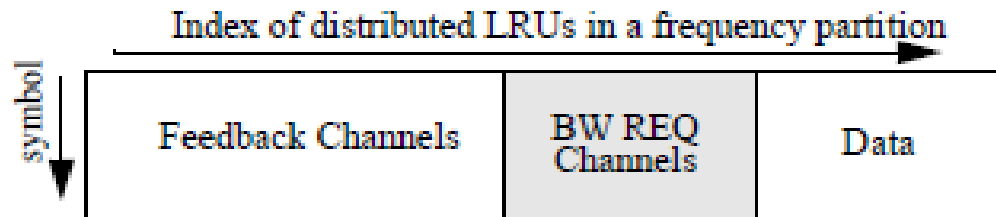

Allocation of UL control and data channels in the distributed LRUs of a frequency partition of an UL AAI subframe.

Figure 523—Allocation of channels in the UL frequency partition

# Fast feedback Channels

- Primary & Secondary- Fast feedback Channels
  - Three 2x6 Feedback mini-tiles
  - Supported features: MIMO mode selection, Band selection, CQI, PMI, Event driven reports (buffers overflow, FFR group selection)

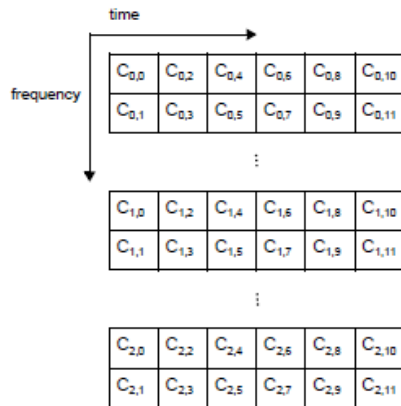

Figure 555—PFBCH comprised of three distributed 2x6 UL FMTs

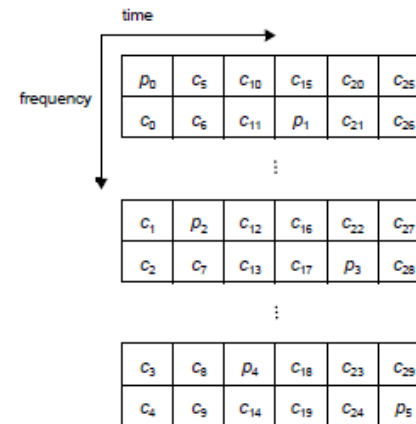

Figure 557—SFBCH comprising of three distributed 2x6 UL FMTs

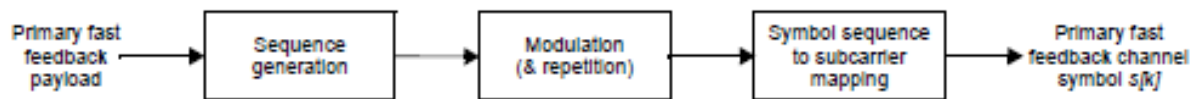

Figure 556—Mapping of information in the PFBCH

# BW REQ, HARQ, Ranging & Sounding

## – BW request

- Three 6x6 UL-tiles (same as UL data tile)
- Fast 3 stages BW REQ, by attaching certain info. (MS identification and required allocation size)
- Fall-back 5 stages BW REQ (16e like BW)

## – HARQ Feedback

- Each HF control CH contains 3 HARQ Mini-Tiles (HMT) sized 2x2 each & carry 2 HARQ feedback channels
- 3 Reordered FMTs (2x6 each) → form 9 HMT → Up to 6 HARQ feedbacks.

## – Ranging

- Asynchronous with two formats, to support large cell sizes
- Synchronous (incl. handover to Femto)

## – Sounding

- For UL CL MIMO and UL Scheduling

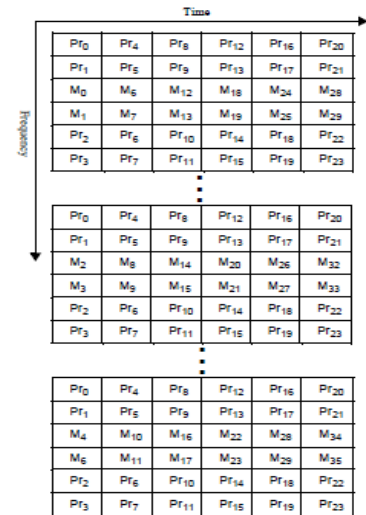

Figure 560—6x6 BR Tile Structure in the Advance Air Interface

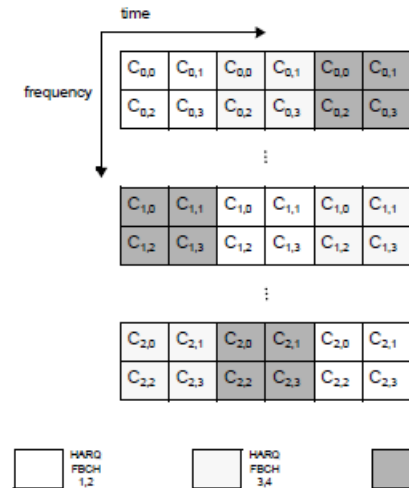

Figure 558—2x2 HMT structure

# Network entry PHY stages

	Operation	Transmission	Useful properties
1	Coarse symbol timing, superframe time and frequency sync.	PA-Preamble	½ symbol periodicity, same signal is transmitted by all of the BSs
2	Cell selection	SA-Preamble	Reuse-3, 768 sequences
3	Obtaining system cnfg.		
3.1	Essential system configuration	P-SFH → S-SFH (SP1 and SP2)	P-SFH location and code-rate are fixed, and tells the S-SFH parameters
3.2	Less essential configurations	SP3 of SFH + ABI (Additional Broadcast Information)	Not urgent for network-entry
4	Read A-MAP		
4.1	Get A-MAP cnfg. In current subframe	Non User Specific (NUS)	Code-rate and permutation parameters are known from SFH
4.2	Try to get DL/UL assignments	A-A-MAP	Code-rate and location are known from NUS. CRC is masked with STID to identify the assignments' destination
5	Async Ranging	UL ranging → RNG_ACK	

# DL/UL MIMO



# MIMO – DL TX diagram

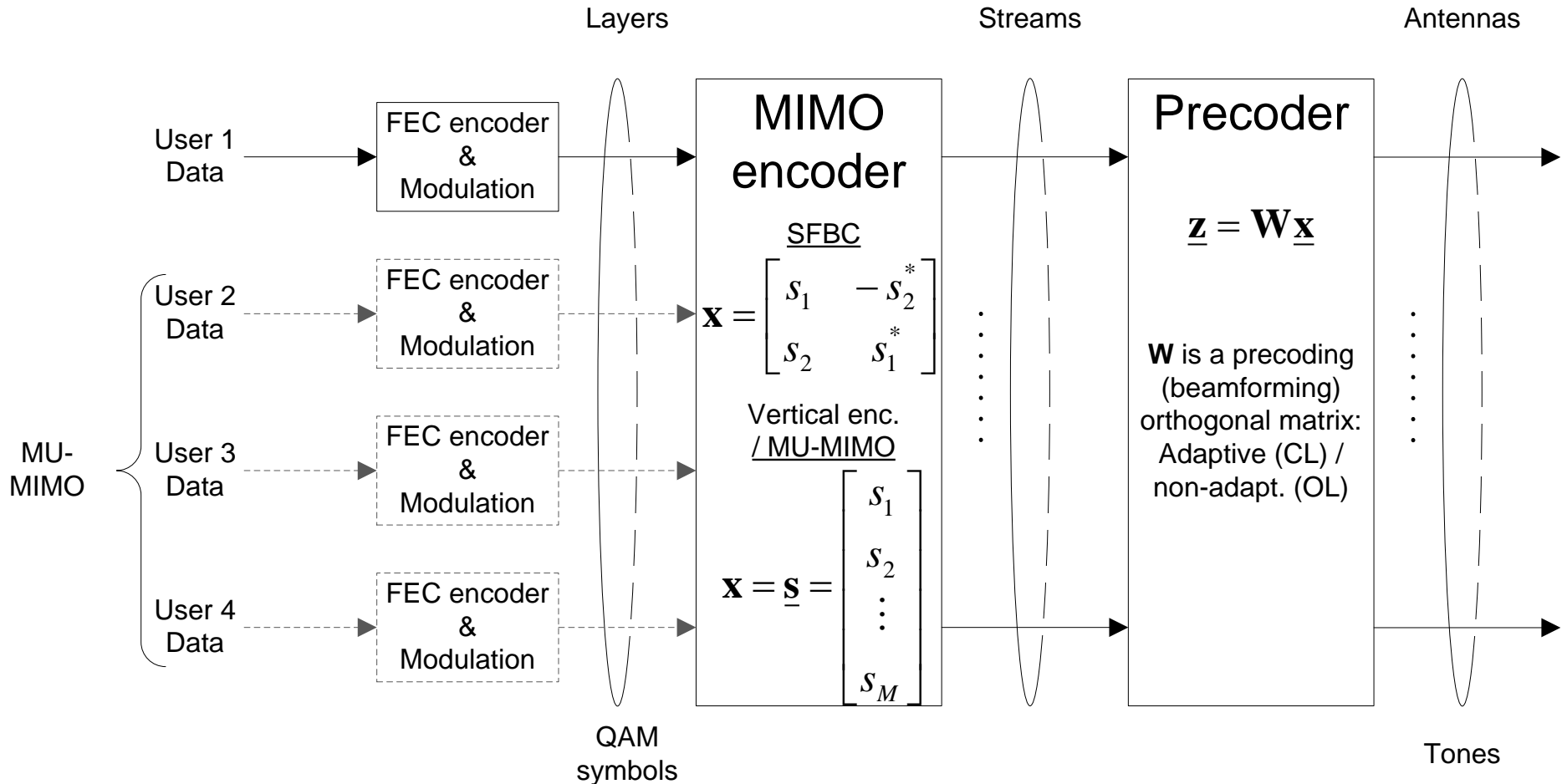

# MIMO Terminologies Definitions

- **Layer:** An information path fed to the MIMO encoder as an input, which is the output of a single FEC encoder and modulator
- **Stream:** Each information path encoded by the MIMO encoder that is passed to the precoder
- **MIMO Rate (rank):** The number of QAM symbols signaled per array channel use. For the spatial multiplexing modes in SU-MIMO, the number of streams to be used for the user allocated to the Resource Unit (RU)
- **Single User MIMO:** A MIMO transmission scheme in which a single MS is scheduled in one RU
- **Multi-User MIMO:** A MIMO transmission scheme in which multiple MSs are scheduled in one RU, by virtue of spatial separation of the transmitted signals (SDMA)
- **Vertical encoding:** Indicates transmitting a single FEC-encoded layer over multiple antennas. The number of encoded layers is always 1. Used in SU-MIMO. Horizontal encoding is used for Multi-User, where each user is assigned to 1 stream at most.



# Overview of DL MIMO

- Key features of 802.16m DL MIMO
  - Single-BS and Multi-BS MIMO
  - Single-User MIMO (SU-MIMO) and Multi-User MIMO (MU-MIMO)
    - Vertical encoding for SU-MIMO
    - Horizontal encoding for MU-MIMO
  - Adaptive-precoding (closed loop) and non-adaptive (open loop) MIMO precoding
  - Codebook and sounding based precoding
    - Short and long term adaptive precoding
    - Dedicated (precoded) pilots for MIMO operation
  - Enhanced codebook design
    - Enhanced base codebook
    - Transformed codebook
    - Differential codebook

# Key MIMO Features

- **Single-BS and Multi-BS MIMO**
- **SU-MIMO & MU-MIMO**
- **OL-MIMO & CL-MIMO**
- **Various Encoding types:**
  - SFBC (Space Frequency Block Code): Uses two streams and rate=1
  - Single stream Tx ("SISO") -- SISO with one stream (rank-1)
  - Spatial-Multiplexing (SM) (e: Matrix-B) of 2-8 streams
  - MU-MIMO – SM with horizontal encoding (1 stream/user)
  - CDR (Conjugate Data Repetition) : 1 stream, rate=1/2
- **Precoding types:**
  - Non-Adaptive precoding (i.e. Open Loop): predefined precoder predefined across frequency bands and constant in time, MS selects best-M subbands with effective channel = channel + precoder
  - Adaptive precoding (Closed Loop): (1) codebook based - the MS choose best matrix from codebook, or (2) sounding based for TDD

# 16m DL MIMO classification

## Single BS-MIMO

CL-SU CL-MU OL-SU OL-MU

Localized Allocations

OL-SU

CL-SU  
(LT BF)

CL-MU  
(LT BF)

Distributed Allocations

## Multi-BS MIMO

PMI restriction PMI recommendation

Single BS w/ PMI  
coordination

CL Macro Diversity Collaborative MIMO

Multi BS precoding w/  
coordination

# Coding and HARQ

# FEC

- Turbo Code
  - Minimal code rate 1/3
  - FEC block sizes ranging from 48 to 4800
  - Bit grouping: solve the 64QAM degradation problem
  - FEC CRC and burst CRC
- Burst size signaling
  - A small set of burst sizes and simple concatenation rule
  - Rate matching -> continuous code rate

# HARQ

- HARQ coding
  - HARQ-IR:
    - 4 SPID defined for DL, signaled in A-MAP
    - Contiguous transmission in UL
  - CoRe: 2 versions for 16QAM and 64QAM
    - DL: CoRe version signaled in A-MAP
    - UL: CoRe version change when circular buffer wrap around



# TBCC for Control Channel

- Control channels (DL: SFH and A-A-MAP; UL: SFBCH and BWREQ) FEC is based on 16e TBCC with some modifications
  - Minimal code rate is 1/4 for DL and 1/5 for UL
  - New puncturing scheme (“random” puncturing with subblock interleaver and rate-matching)

# Incremental Redundancy HARQ

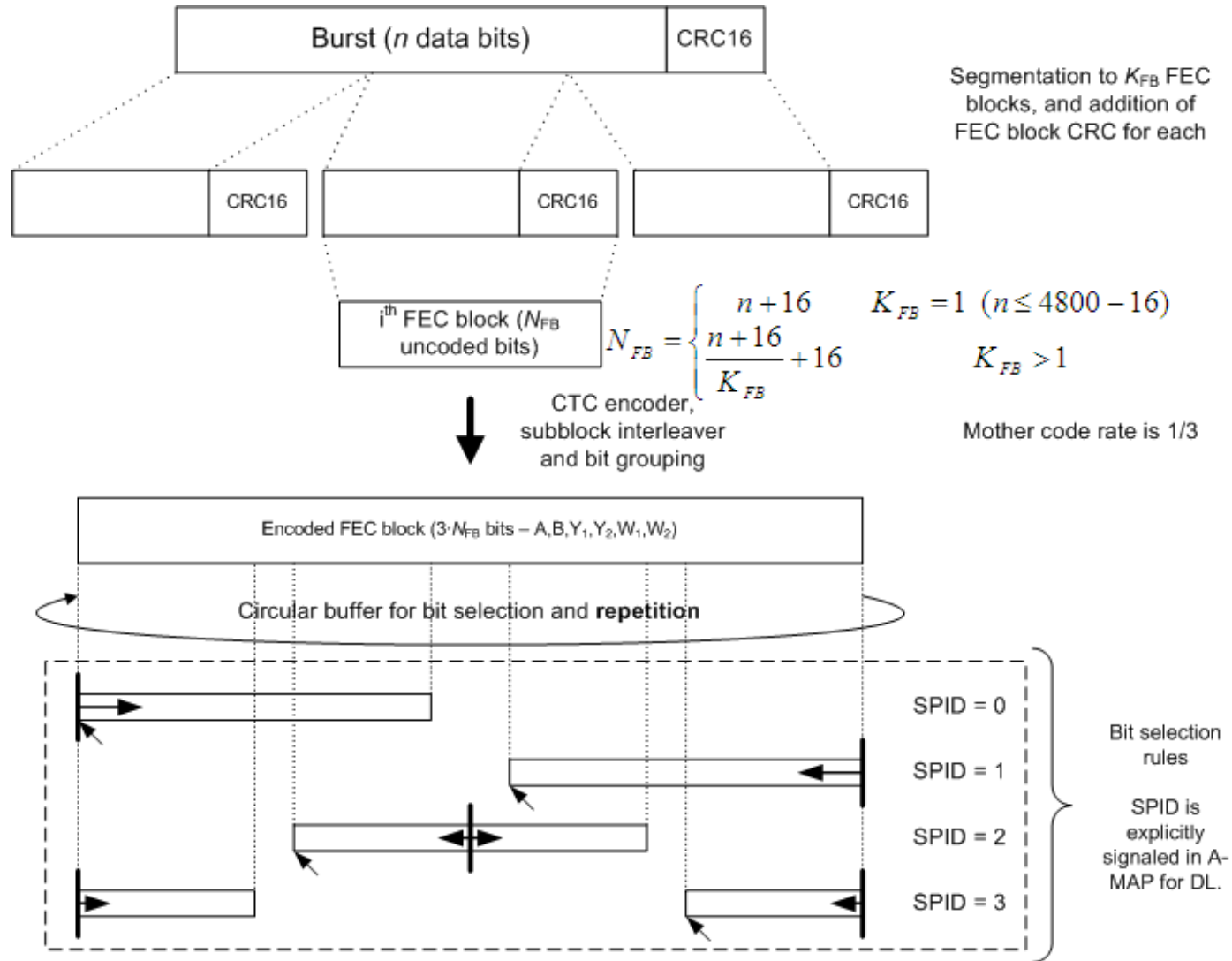

# IEEE Project 802.16m: Key Documents

- [P802.16m PAR](#) and [Five Criteria Statement](#)
  - Project Authorization: Scope, Purpose, deadline, etc.
- [Project 802.16m Work Plan](#)
  - timeline
- [Project 802.16m System Requirements Document \(SRD\)](#)
  - high-level system requirements for 802.16m project (“Stage 1”)
- [Project 802.16m System Description Document \(SDD\)](#)
  - system level description based on the SRD (“Stage 2”)
- [Project 802.16m Evaluation Methodology Document \(EMD\)](#)
  - link-level and system-level simulation models and parameters
- Draft 802.16m amendment standard or “Stage 3”

# Acknowledgment

- Tom Harel
- Hujun Yin
- Yang-seok Choi
- Yi Hsuan
- Huaning Niu
- Jose Puthenkulam
- Xiaoshu Qian
- Alexei Davydov
- Xinrong Wang

# Thank You



# Backup Slides



# Multi-Carrier Support

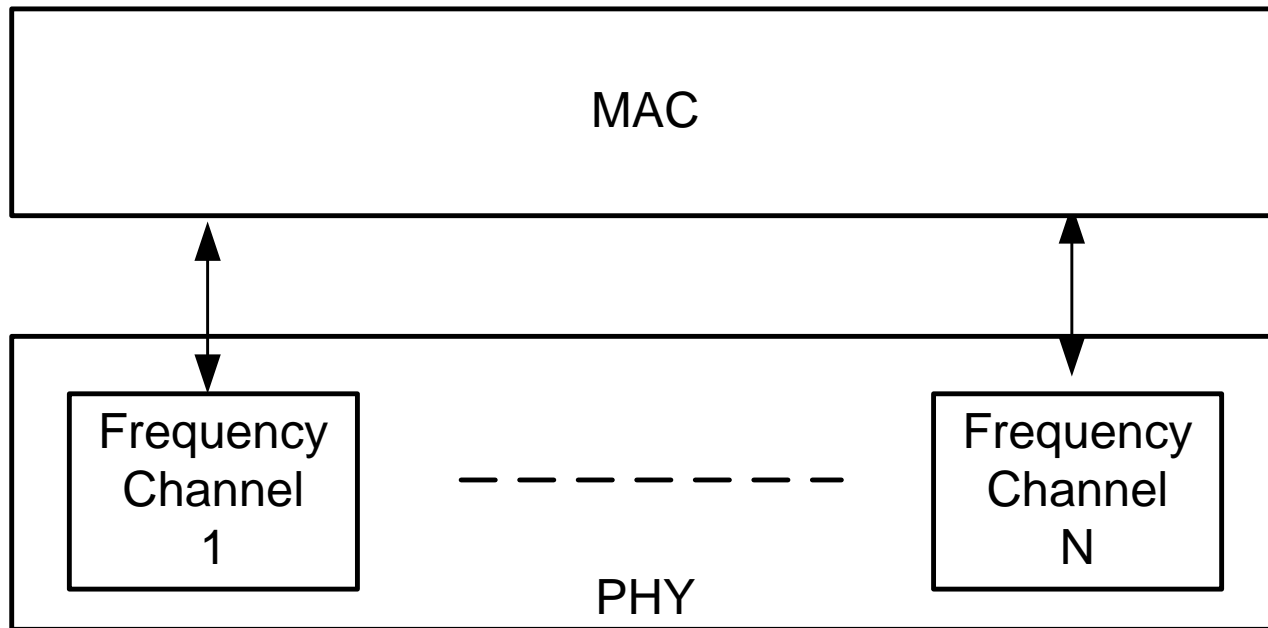

# Multi carrier

- Primary vs. secondary channels
- Partially vs. fully configured channels
- Subcarrier alignment and transmission on guard subcarriers

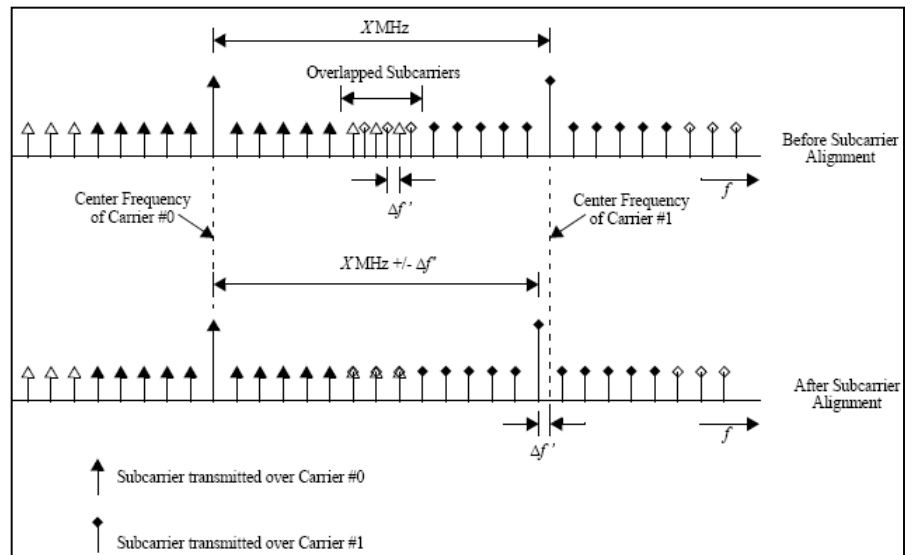
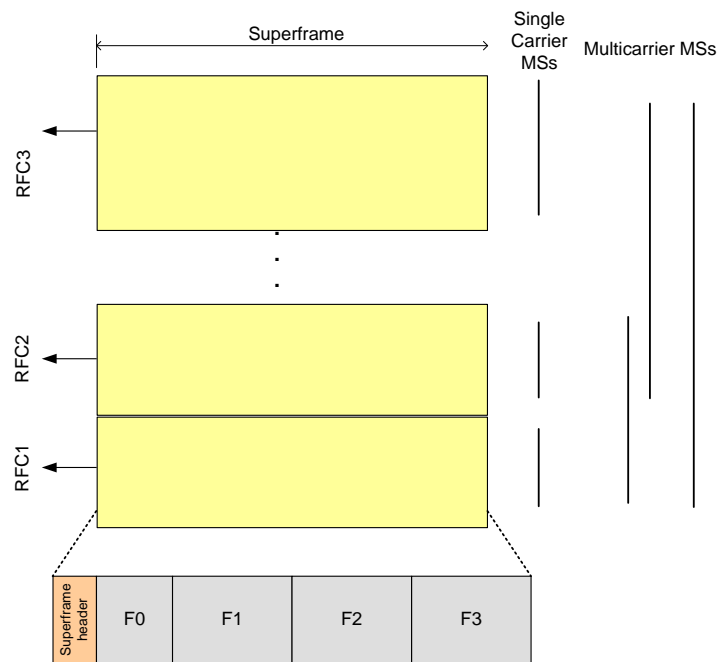

SF 0	SF 1	SF 2	SF 3	SF 4	SF 5	SF 6	SF 7
------	------	------	------	------	------	------	------



# 802.16e & 802.16m Comparison

Feature	IEEE 802.16e/Mobile WiMAX R1*	IEEE 802.16m*
IMT-Advanced 1Gbps	Not planned	>1Gbps with 3x20MHz Multicarrier
Duplexing Modes	TDD	TDD, FDD
Channel Bandwidths	5, 3.5, 7, 8.75, 10 MHz	5, 10, 20, 40 MHz
Peak Data Rates	DL: 64 Mbps (2x2) @ 10 MHz UL: 28 Mbps (2x2 CSM) @ 10 MHz	DL: > 300 Mbps (4x4) @ 20 MHz UL: > 135 Mbps (2x4) @ 20 MHz
Mobility	Up to 60-120 km/hr	Up to 350 km/hr
Latency	Link-Layer Access: ~20ms Handoff: ~35-50ms	Link-Layer Access: <10ms Handoff: <30ms
MIMO Configuration	DL: 2x2 MIMO UL: 1x2 MIMO	DL: 2x2, 2x4, 4x2, 4x4 MIMO UL: 1x2, 1x4, 2x2, 2x4 MIMO
Average Sector Throughput TDD (DL: UL=2:1)	DL: 25 Mbps (achieved by band AMC) UL: 6 Mbps @10 MHz	DL: > 35 Mbps (min. requirements) UL: > 8.7 Mbps @ 20MHz
Spectral efficiency (per sector)	Peak: DL 6.4 bps/Hz, UL 2.8 bps/Hz Sustained: DL 1.55 bps/Hz, UL 0.9 bps/Hz	Peak: DL > 15 bps/Hz UL > 6.75 bps/Hz Sustained: DL > 2.6 bps/Hz, UL > 1.3 bps/Hz
Coverage (km)	1/5/30 km	1/5/30km (Optimal at 5km)
Number of VoIP Active Users	~ 25 users/sector/MHz	> 60 users/sector/MHz

•Source: Intel Corporation & IEEE 802.16m System Requirements Document

Copyright Intel Corporation © 2008



# Fractional Frequency Reuse - IM

- FFR across sectors to create multiple reuse settings in a cell
- Implemented by creating frequency partitions with different power levels
  - Each partition incurs a cost due to system resources (power, bandwidth) used
  - Best (system-wide) resource for MS is selected based in S/I per resource and system cost of resource
- Performance gains of 20% for all users and up to 90% for cell-edge users
- Frequency Partition Adaptation is a slow process and network controlled

- **Frequency Partitions:**  $K = 3 \sim 7$  partitions to support reuse 1, 2/3, 1/3
  - **Attributes of each Partition**
    - Bandwidth/Resource units ( $W$ )
      - Power level ( $P$ )
    - Resource cost metric ( $C$ ) (transmitted by BS)
  - **Soft reuse** achieved by setting power level of each partition based on feedback by the MS about the best partition based on Cost ( $C$ )

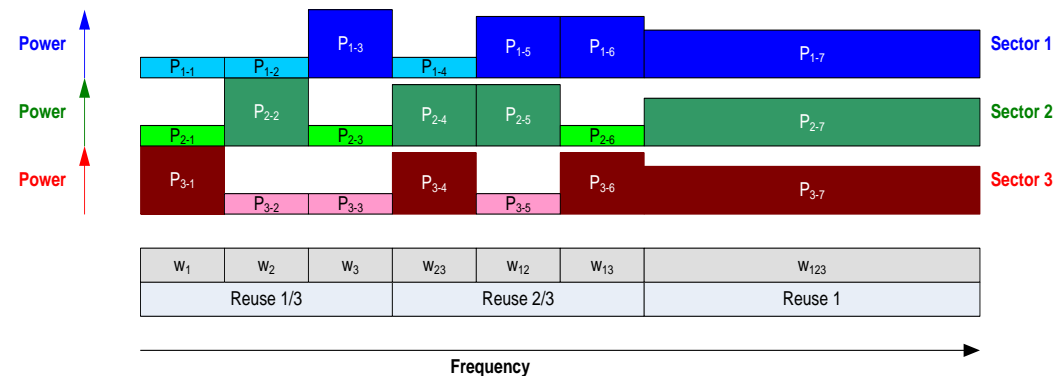

# Multi-Hop Relay-Enabled Architecture

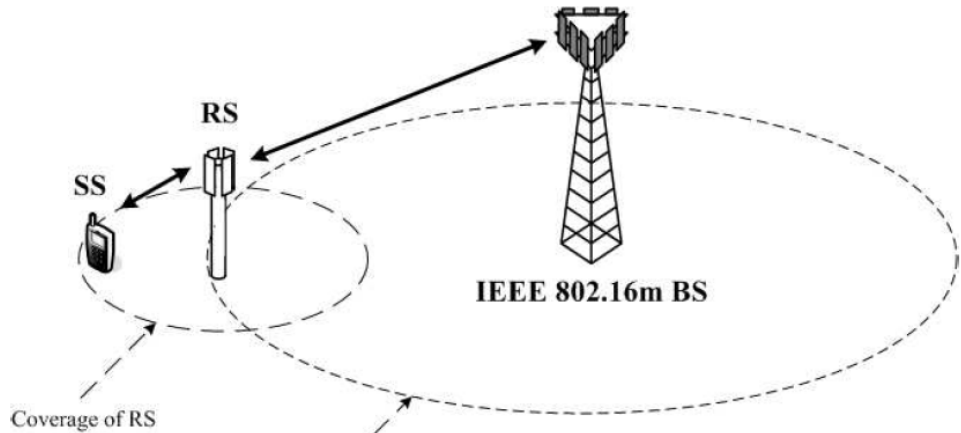
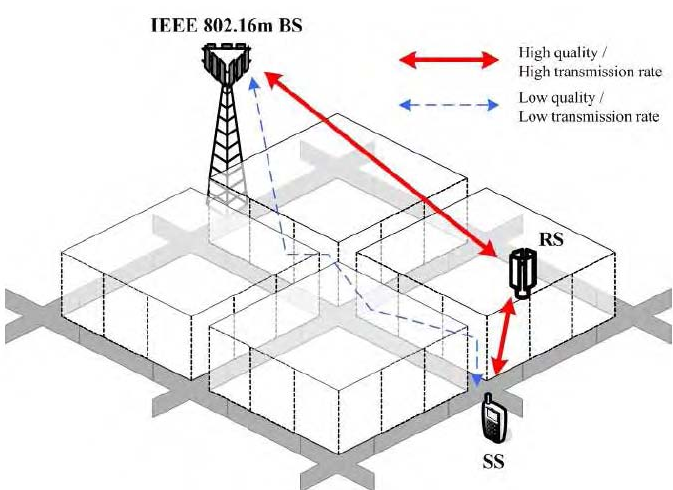

Relays can enhance transmission rate for the MS located in shaded area or cell boundary

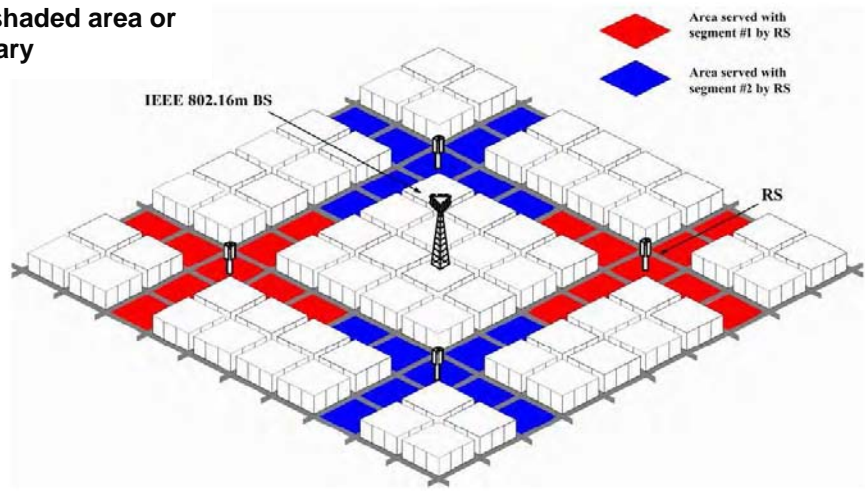

More aggressive radio resource reuse by deploying RS in IEEE 802.16m network



# Enhanced Multicast and Broadcast Service (E-MBS)

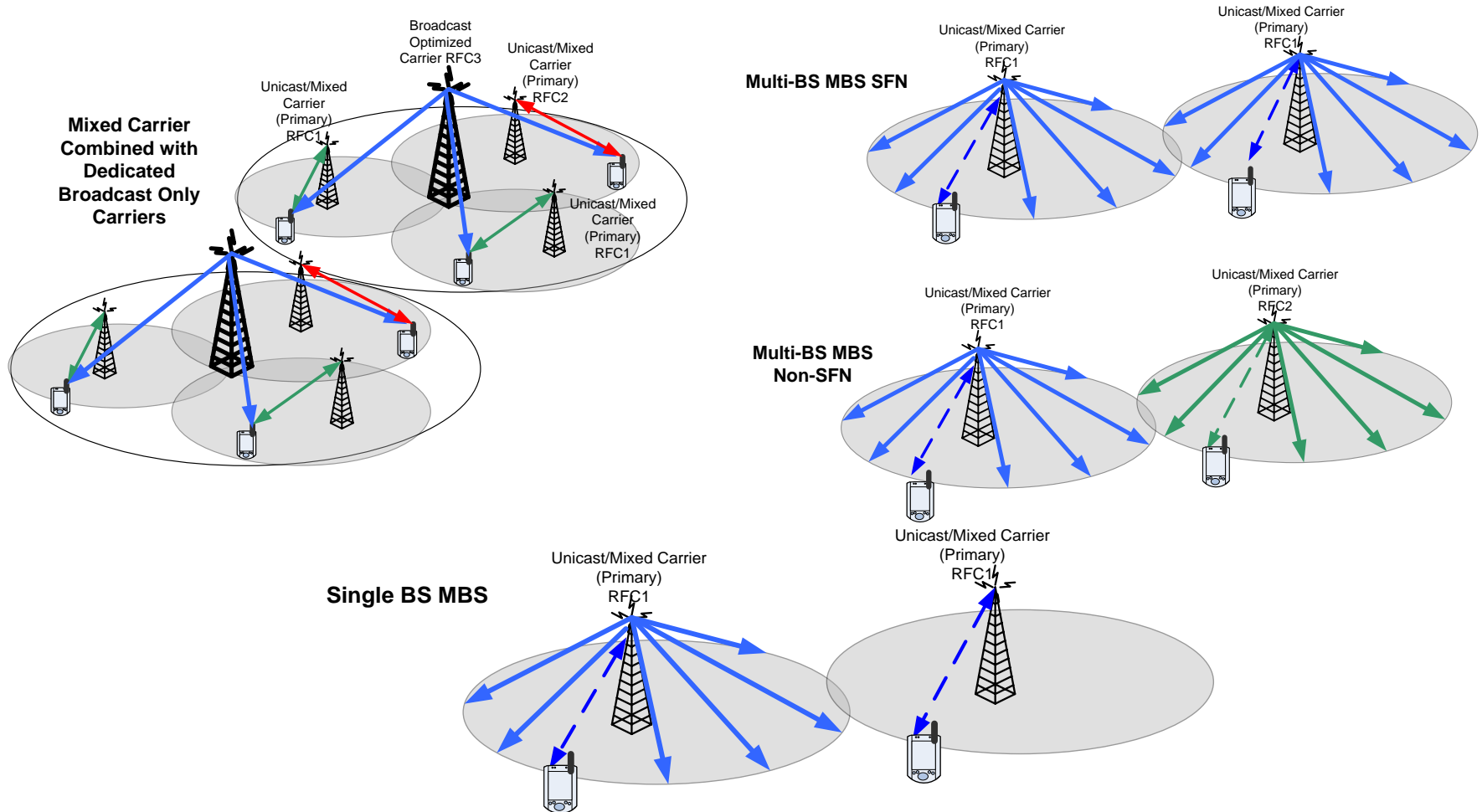

eMBS can be multiplexed with unicast services or deployed on a dedicated carrier

# Support of Femto-Cells and Self-Organization

- Femto-cell support to offer service providers greater deployment flexibility
- Self-configuration support to enable plug and play installation; i.e. self-adaptation of initial configuration, including neighbor update as well as means for fast reconfiguration and compensation in failure cases.
- Self-optimization support to enable automated or autonomous optimization of network performance with respect to service availability, QoS, network efficiency, and throughput.

