

# Region 4 & 6 Learning Lab for Chapter Recording and Distribution

- San Diego, CA
- 25-Jan-2015
- John Walz, Director 2015-16, IEEE Board

IEEE  
SECTIONS  
CONGRESS  
/// 2014

# Outline

1. Introductions
2. Purpose, Goal - Coughlin
3. Benefits, Value - Walz
4. Big Picture: Chapter Technical Meetings, ?
5. Big Picture: Technology, Fallenstein
6. How connect & record audio, Dennison
7. How make video recordings, Wei
8. Lab experiences
9. Optional Post-editing, Luo?
10. Q&A → Commitment

# 1. Introductions

- Train-the-Trainer
  - Ron Dennison
  - Mike Fallenstein
  - Xun Luo
  - Joseph Wei
- Champions
  - Tom Coughlin
  - Bob Parro
  - John Walz
- Section Officers
  - “trainers”
- Regional Officers
- IEEE staff
  - Ray Kahn
  - Pradeep Pamula
  - Ted Rozolis
  - Steve Woods

## 2. Purpose, Goal

# Goal

---

- ▶ Demonstrate an opportunity to create a new class of Intellectual Property (IP) that benefits members.
- ▶ Shows methods for capturing IEEE local Chapter technical meeting presentations and
- ▶ Provides a way for these recorded presentations to be stored and accessed by IEEE members
- ▶ Recordings will be a video of the presentation combined with the voice of the presenter.
- ▶ IP will provide membership value, increase MGA/TAB technical assets, and attract funding for improved Chapter programs.

# Current Barriers

---

- ▶ Some Sections / Chapter geography limit high attendance at Technical Meetings
- ▶ Members who miss the Technical meeting, never have another viewing opportunity
- ▶ Technical meeting slides are mostly not archived on Sections / Chapter websites
- ▶ Call for Lecturers do not offer ongoing publicity / visibility of their talk
- ▶ Sponsoring Societies focus is on peer review articles for Xplore, and not on Technical Meeting recording & archive

# Motion

- IEEE Computer Society MGA supports for conducting Chapter Technical Meeting Recording and Archive pilots in Region 6, with technical advice from staff
  - John Walz, Division Director-elect
  - Tom Coughlin, Region Director-elect
  - IEEE Computer Society MGA ExCom
  - 5-Feb-2014

# IEEE NEW INITIATIVE: SEED GRANT PROPOSAL

Proposed New Initiative	
Initiative Name	Chapter Technical Meeting Recording & Distribution
Initiative Number	<i>To be assigned upon submission</i>
Date Submitted	8-June-2014
Initiative Leader Contact	Tom Coughlin, Region 6 Director Elect
Alternate Contacts	John Walz, Division 8 Director-Elect
Contacts E-Mail Addresses	<a href="mailto:tom@tomcoughlin.com">tom@tomcoughlin.com</a> , <a href="mailto:j.walz@computer.org">j.walz@computer.org</a>
Phone/Extension	408-202-5098, 630-961-3222
Organizational Unit Sponsor(s)	MGA Region 6 and Computer Society

1. **Abstract** (not to exceed 100 words)

**Provide a description of the proposed initiative to be funded by a one year seed grant.**

**An Opportunity to Create A New Class of IP that Benefits Members:** Capturing IEEE local section chapter technical meeting presentations and providing a way for these recorded presentations to be stored and accessed by IEEE Members. These recordings will be a video of the presentation combined with the voice of the presenter. This IP will provide membership value, increase MGA/TAB technical assets, and attract funding for improved Chapter program



# Learning Lab Purpose - Tool Demo as part of a process

---

- ▶ Demo a capability
  - How to use it
  - Help audience understand how easy it is to use
  - How volunteers can incorporate in a meeting when they return to their units
- ▶ Engage the audience
  - Ask if they used the product and/or process
  - Identify issues users may have experienced

# 3. Benefits, Value

# Technical meetings provide value

- ▶ Technical meeting is an important product and service to both Section, Chapter, and Society members
  - Provide membership value in terms of education and networking
  - Attracts new and retains members
  - Attractive to Industry Professionals
- ▶ Show the vitality of the Section/Chapter leadership
- ▶ Section & Chapter leaders are motivated to select the best fit lecturer for their local membership
- ▶ Builds IEEE Brand locally
- ▶ Industry Practitioners especially values Chapter Technical Meetings
- ▶ Many Lecturers first public experience is in front of their Section or Chapter

# Technical Meetings could be a new IEEE Intellectual Property

- ▶ All IP has an segmented audience with a variety of price points

You **Tube**



**WILEY**



University of Phoenix®

**Stanford** | ONLINE



# Value for stakeholders

- ▶ Local Chapter, Section, and Region members
  - miss a technical meeting
- ▶ Society's related technical communities
  - Global access
  - IP offering: abstract, speaker bio, pdf slides, and Camtasia video file
- ▶ IEEE members involved in continuing education
  - Membership value
  - searchable metadata
- ▶ Non-IEEE members
  - consumers of IEEE store
  - realize the advantages of joining the associated Society and/or IEEE

# Global access from Section/Chapter & sponsoring Society websites

---

- ▶ Chapters and their Societies could build up Technical Meeting IP along with searchable metadata
- ▶ IP offering: abstract, pdf slides, speaker bio, and Camtasia video stream and downloadable file
- ▶ Membership value

# 4. Big Picture: Chapter Technical Meetings



# Technical Meeting Time Line

1. Section / Chapter Program select local interesting topic
2. Call for Lecturers on this topic
3. Lecturer submission
  - Author Name, photo, bio, title, keywords, description, willingness to release IP, availability dates
4. Acceptance with date; Author signed release form
5. Technical Meeting announcement
6. Technical Meeting
  - Presentation laptop load & install, configuration test
  - Record live presentation, Q&A
7. Recording preview, submission, & distribute
8. Post editing option
9. Social networking





# 5. Big Picture: Technology



 **TechSmith**

 **IEEE**

# Big picture

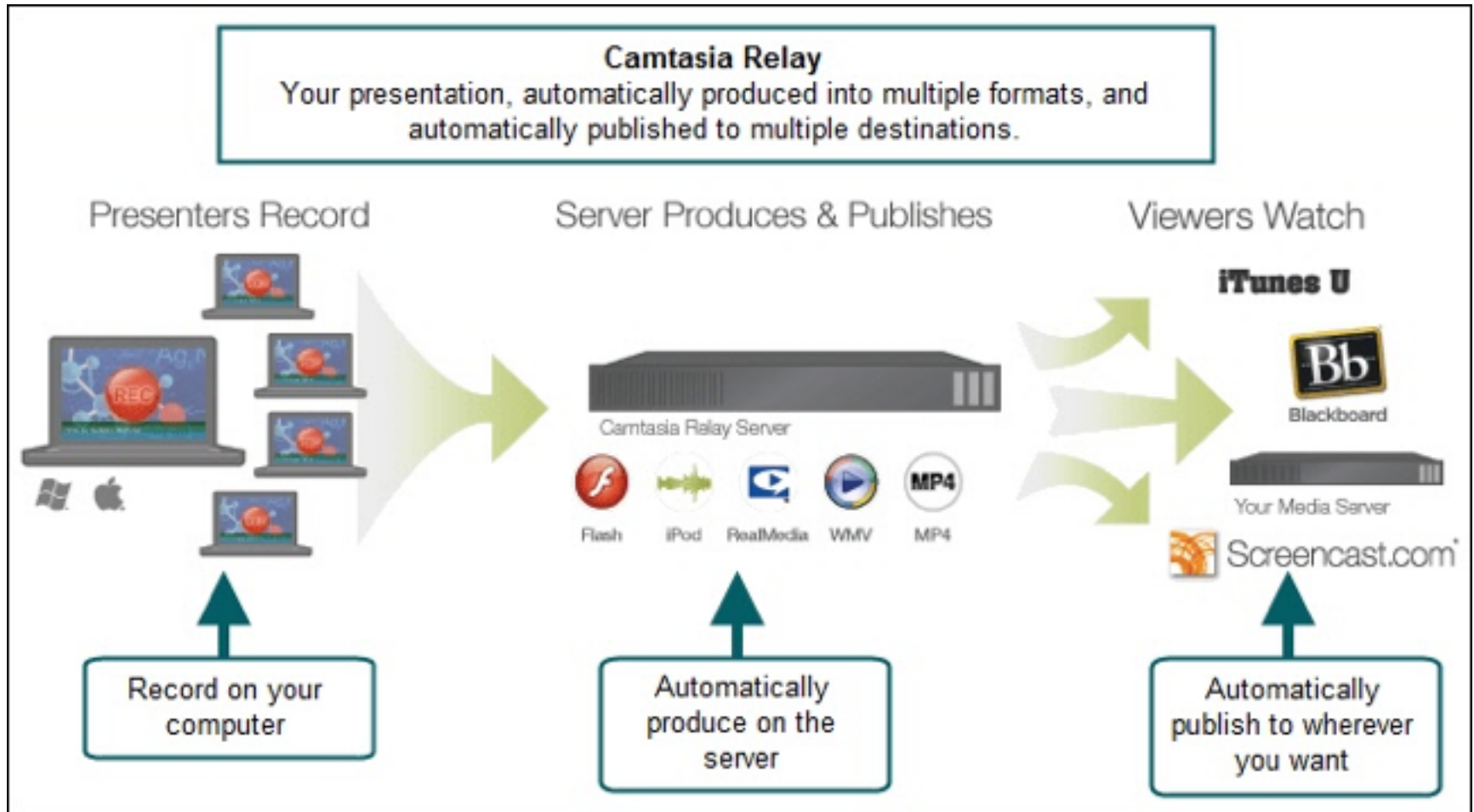

# 6. How connect & record audio

# Audience/Audio Basics

- For small venues (~20-30 people or less) House Audio is Not Required BUT may be used if available
- Use of the built-in laptop microphone is not recommended
- The recommended wireless microphone system supports all presenter styles
  - Podium/fixed
  - Lavalier
  - Headset
- Set up wireless mic's and receiver in accordance with system manual
- Recommend headset mic for presenter and handheld for audience



# Connection to PC and Mixer

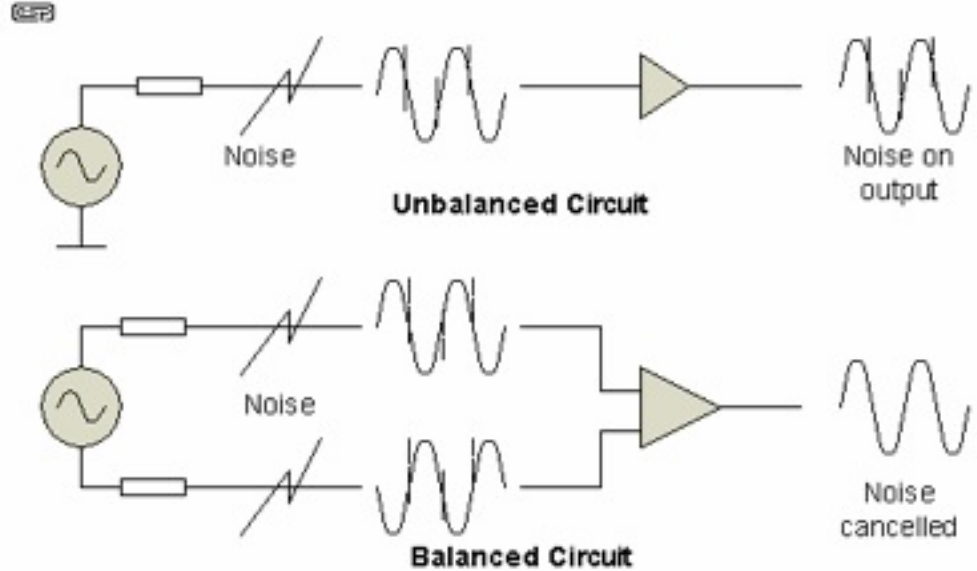

Use of balanced cables is only necessary with very long cable runs or when the audio cable is run alongside ac power cables

# CASE 1 - No house audio (small group) Hookup to Camtasia PC Only



# CASE 2 - Using House audio With access to mixer



1/4" TS phone plug

XLR Cables



1/8" TS phone plug

Laptop



Mixer

# CASE 3 - Using House audio WITHOUT access to mixer

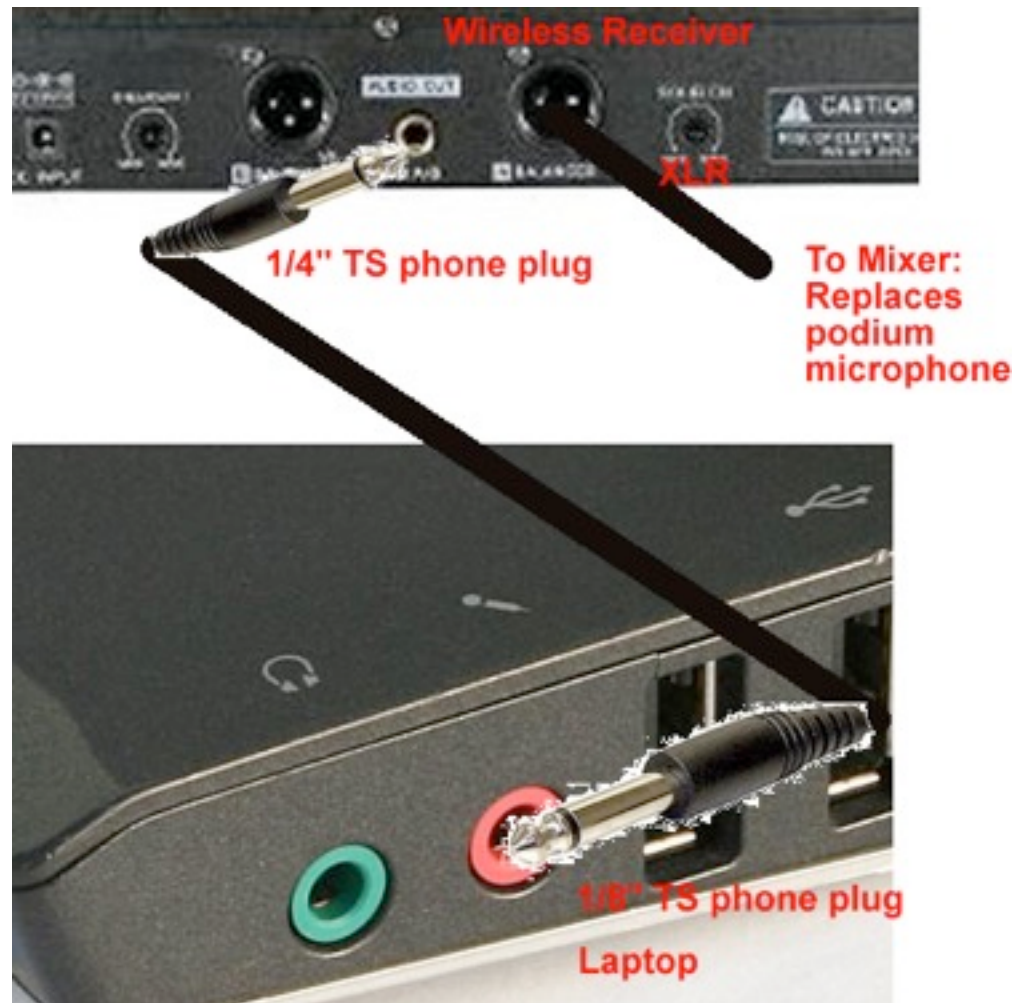



# Microphone and Recording Basics

- Distance/Position is everything!
- Each Microphone has different/unique requirements

Handheld dynamic microphone  
4" ~45 degrees out of plane

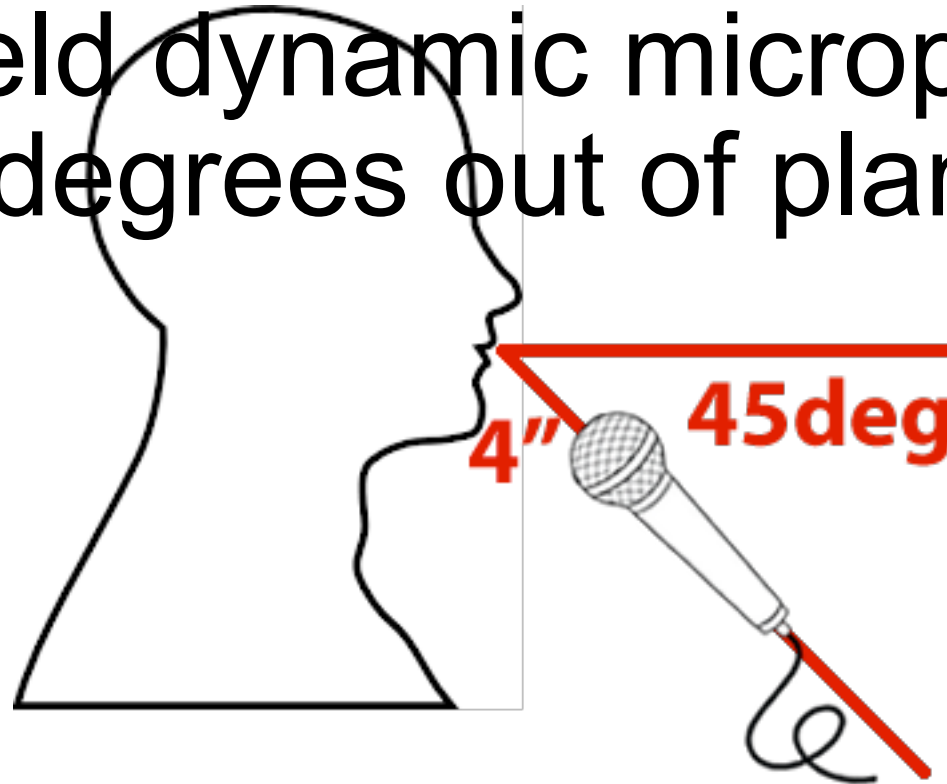

Lavalier (midline as close to throat as possible)



Headset - corner of mouth, flat/front of transducer facing and parallel to face



# Putting it all together

- Make a short test recording
- Check level, clarity
- 5 volume/gain controls
- Avoid highest gains due to potential distortion
- Troubleshooting

# 7. How make video recordings

- Download and install software on presentation laptop
- Acquire Presenter's copyright
- Make a Video Recording (12 steps)
- Submit recording for encoding on server
- Receive email with recording URL link

# Login for software install

The image shows a web browser window with the address bar displaying `https://ca-camtasia.ieee.org/Relay/`. The browser's address bar includes navigation buttons (back, forward, home, refresh) and a search icon. Below the address bar is a menu bar with various search engines and services like Yahoo!, Google Maps, and TripAdvisor. The main content area features the Camtasia Relay logo and a login form. The form has two input fields: 'Username:' with the text 'John Walz' and 'Password:' with masked characters. A 'Forgot your password?' link is positioned below the password field. A 'Sign In' button is located at the bottom right of the form. Below the login form is a dark grey navigation bar with three columns: 'Manage Presentations' (with a sub-description: 'Find links to all your presentations and check the progress of ones you've just uploaded'), 'Manage Accounts' (with a sub-description: 'Store usernames and passwords for a variety of publish destinations'), and 'Download Camtasia Relay' (with a sub-description: 'Sign in to the website to download Camtasia Relay for Mac or Windows'). The footer of the page contains the text 'Camtasia Relay - 4.3.1.3819 | © 2008-2013 TechSmith Corporation'.

Camtasia Relay®  
TechSmith

Username:  
John Walz

Password:  
\*\*\*\*\*

[Forgot your password?](#)

**Sign In**

**Manage Presentations**  
Find links to all your presentations and check the progress of ones you've just uploaded

**Manage Accounts**  
Store usernames and passwords for a variety of publish destinations

**Download Camtasia Relay**  
Sign in to the website to download Camtasia Relay for Mac or Windows

Camtasia Relay - 4.3.1.3819 | © 2008-2013 TechSmith Corporation

# Camtasia Relay software downloads

Camtasia Relay®  
TechSmith

Home Presentations Profiles Download Recorders

» Download Recorders » More User: John Walz (John Walz) [Sign Out](#)

### Camtasia Relay Recorders



**Download**  
Windows XP, Vista, 7, 8





**Download**  
Mac OS X 10.6.8, 10.7, 10.8







**Download**  
TechSmith Fuse on iOS





**Download**  
Portable Recorder





**Download**  
TechSmith Fuse on Android



#### Portable Recorder Information

You can run the Camtasia Relay portable recorder from a mobile storage device if there is any reason you cannot (or do not want to) record and upload directly from the presentation computer.

#### How to Install the Portable Recorder

1. Plug in a mobile storage device (such as a USB flash drive) and format the device as FAT32.
2. Click **Download Portable Recorder** and save the PortableCamtasiaRelay.zip file to your computer.
3. Locate and open the saved .zip file.
4. Copy all files from the .zip file onto the mobile storage device. All files from the .zip folder need to be copied to the

#### TechSmith Fuse® for Camtasia Relay Information

TechSmith Fuse is a camera video recorder for iOS and Android devices designed for use with the Camtasia Relay server. TechSmith Fuse records camera video and uploads it to the Camtasia Relay server for automated encoding and publishing.

TechSmith Fuse also can upload existing videos from your library to the Camtasia Relay server.

## IEEE COPYRIGHT AND CONSENT FORM

To ensure uniformity of treatment among all contributors, other forms may not be substituted for this form, nor may any wording of the form be changed. This form is intended for original material submitted to the IEEE and must accompany any such material in order to be published by the IEEE. Please read the form carefully and keep a copy for your files.

TITLE OF PAPER/ARTICLE/REPORT, INCLUDING ALL CONTENT IN ANY FORM, FORMAT, OR MEDIA (hereinafter, "The Work"):

COMPLETE LIST OF AUTHORS:

IEEE PUBLICATION TITLE (Journal, Magazine, Conference, Book):

### COPYRIGHT TRANSFER

1. The undersigned hereby assigns to The Institute of Electrical and Electronics Engineers, Incorporated (the "IEEE") all rights under copyright that may exist in and to: (a) the above Work, including any revised or expanded derivative works submitted to the IEEE by the undersigned based on the Work; and (b) any associated written or multimedia components or other enhancements accompanying the Work.

### CONSENT AND RELEASE



# Make a Video Recording

1. Launch TechSmith Relay Recorder.
2. Log in with your username and password.
3. Click the Audio button and select an audio device in the Select Audio Device dialog.

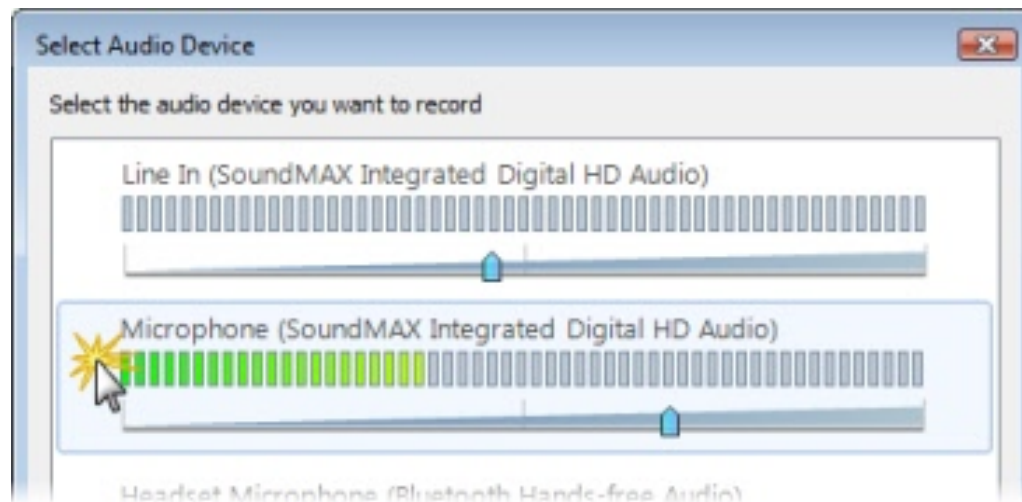

Select Record System Audio to include the sound you hear from your speakers in the recording.

# Make a Video Recording (2/5)

4. Select which display to record if using a projector displaying a different screen or multiple displays.

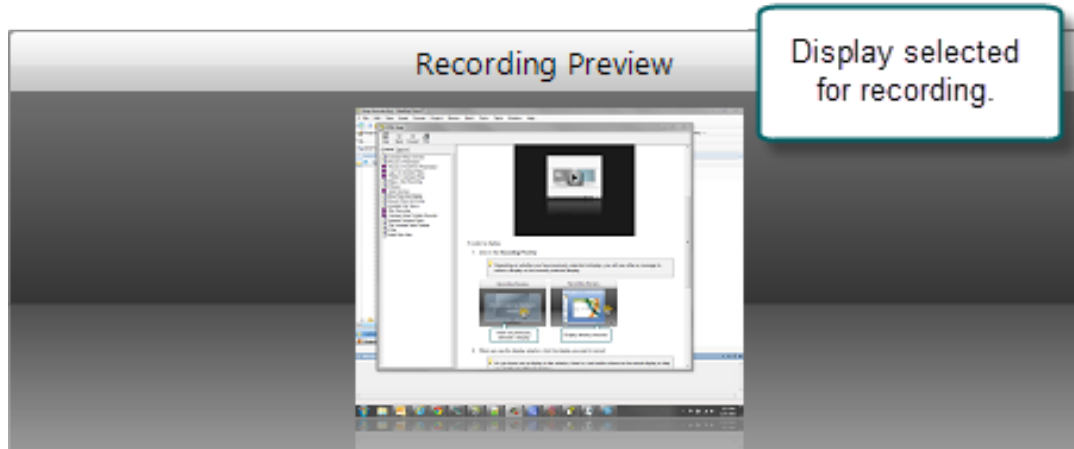
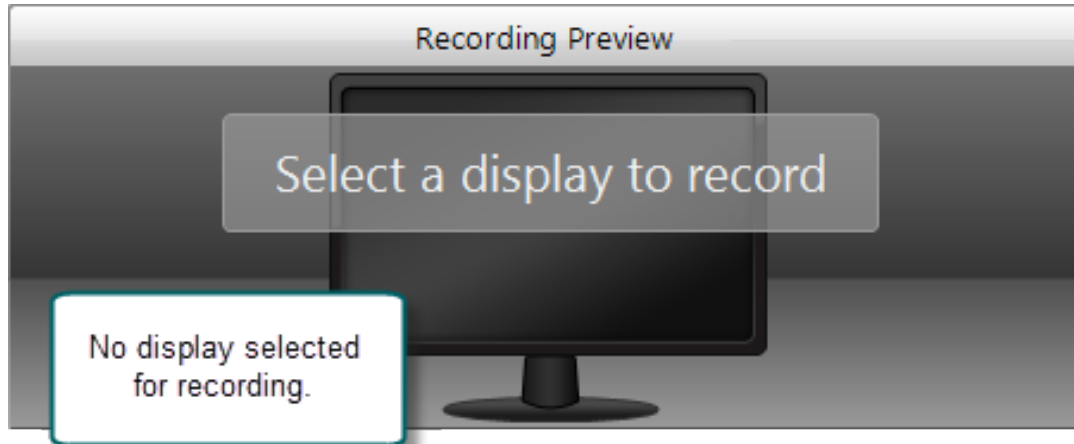

# Make a Video Recording (3/5)

5. Click the Camera button to select a camera to record along with your presentation. This camera is displayed in the lower right corner of your presentation in a picture-in-picture format (optional)

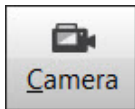

6. Enter a presentation title and description.

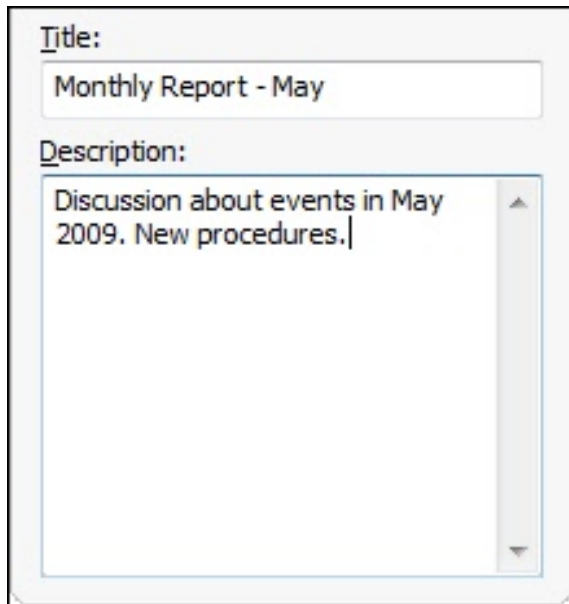
A form with two input fields. The first field is labeled "Title:" and contains the text "Monthly Report - May". The second field is labeled "Description:" and contains the text "Discussion about events in May 2009. New procedures." with a cursor at the end of the line.

# Make a Video Recording (4/5)

7. Make a test recording to verify that you are recording from the correct display, camera, and audio device.

8. Click the Record button. The recorder is minimized to the system tray.

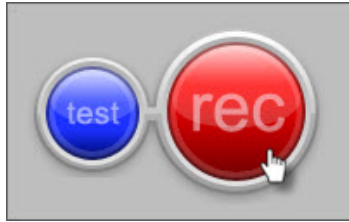

9. Give your presentation. TechSmith Relay Recorder records everything on your screen, selected camera, and the selected audio device.

10. Stop the recording using the icon in the system tray.

## Make a Video Recording (5/5)

11.If needed, click Trimming to set trim points to cut out extra video at the beginning and end of the presentation.



12.Click the Submit button.

If you are connected to the Internet, the presentation starts uploading to the TechSmith Relay website.

If you are not connected to the Internet, the recording automatically starts uploading when you connect to the Internet. You do not receive notice when your presentation begins uploading.

Check the Status of Your Presentation on the TechSmith Relay website.

# 11. Preview and Submit the Recording

After you finish recording your presentation, it opens in the TechSmith Relay Review window.

1. Preview your recording.
2. If you did not do so prior to recording, log in and enter a title and description.
3. If you need to, trim the beginning and end of the recording.

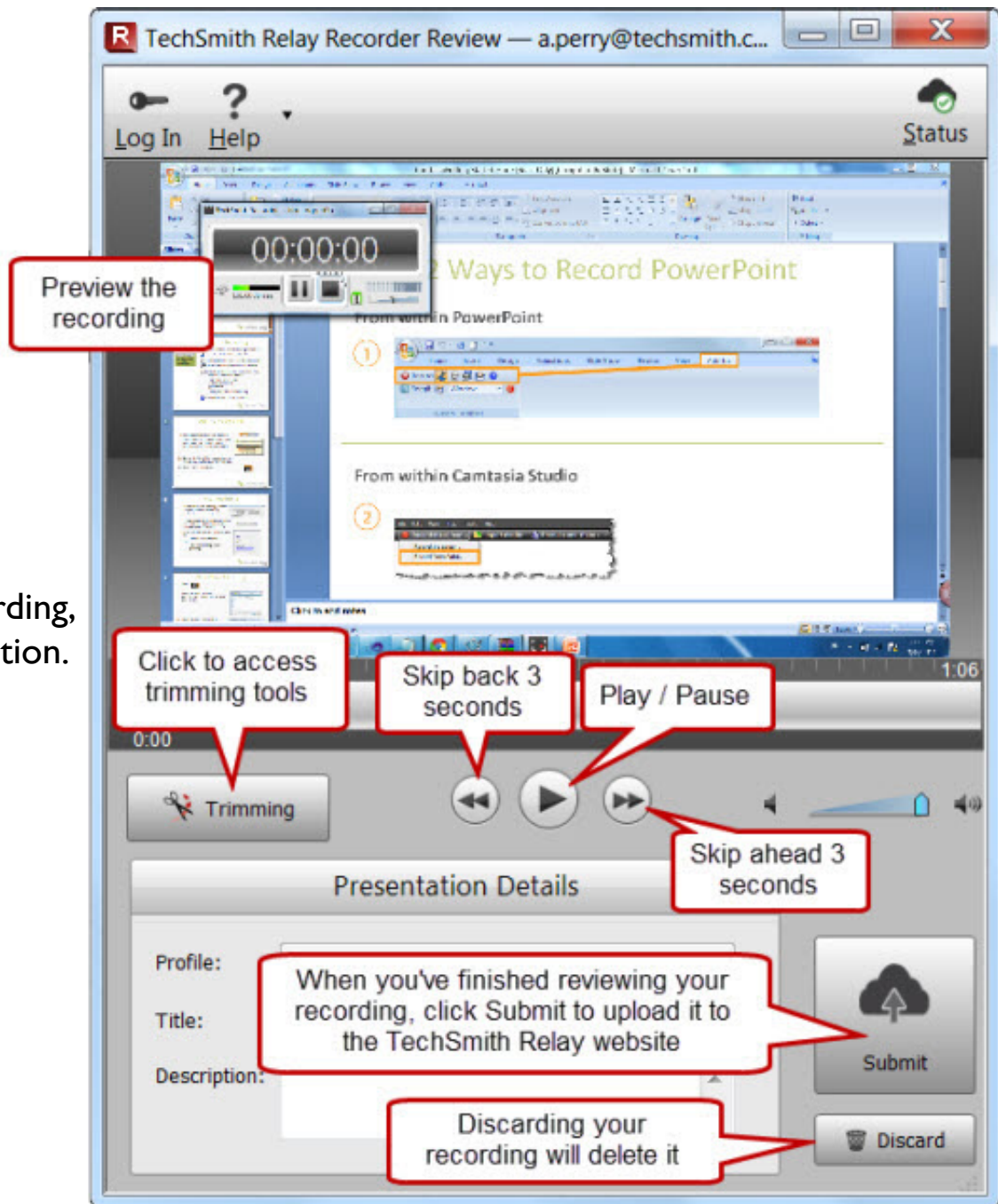

11b.

# Trim, not Discard

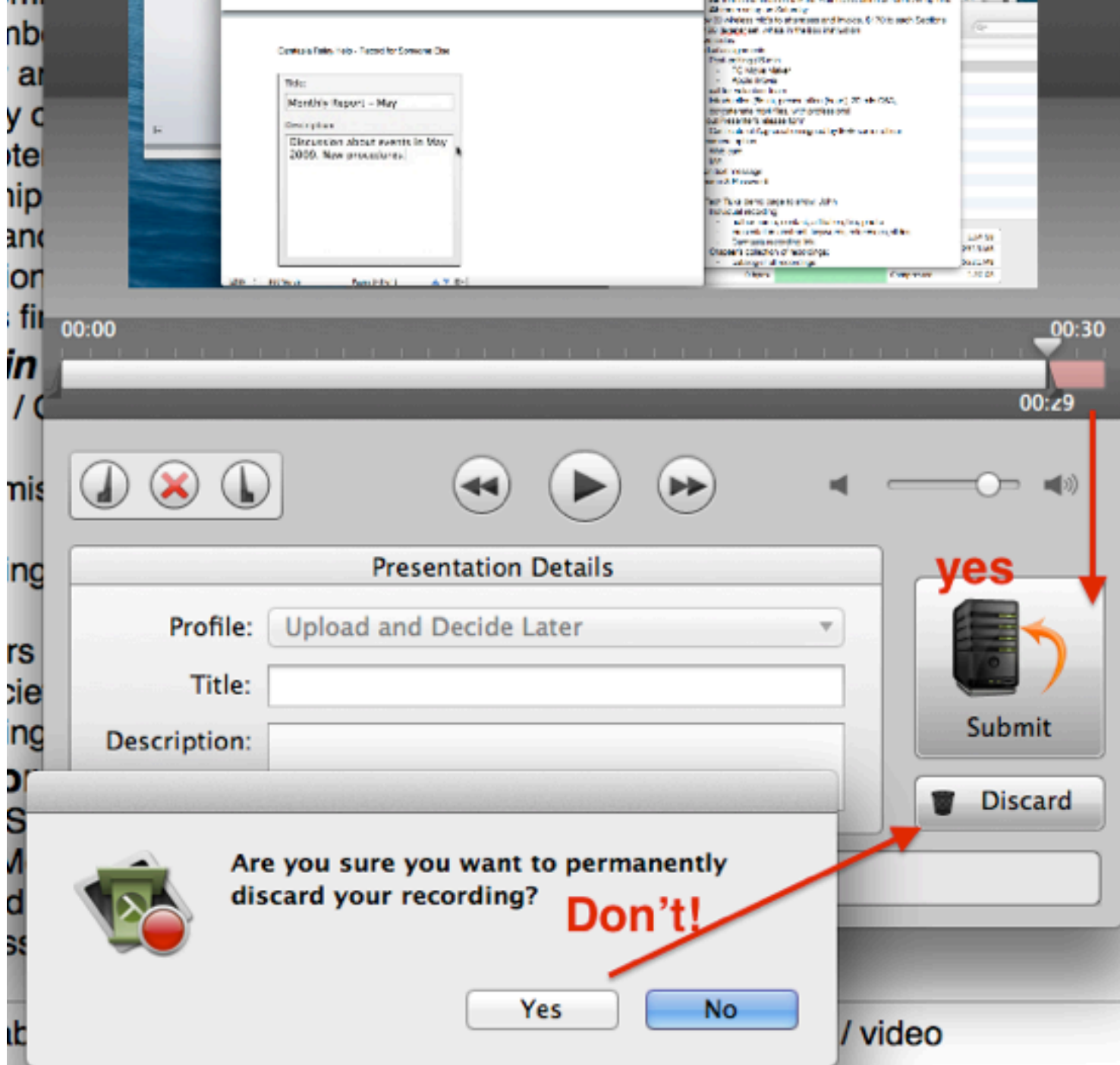

# 12. Camtasia Relay Recording Upload



The screenshot shows a web interface for Camtasia Relay Recording Upload. A modal dialog box titled "Presentation Complete" is centered on the screen. The dialog contains an icon of a computer monitor with an orange arrow pointing to a server rack. Below the icon, the text reads: "The presentation was submitted for upload to the server. If you are currently **online**, the presentation will begin to upload immediately. If you are **offline**, your presentation is now stored on your computer and will automatically begin to upload the next time your computer is online." At the bottom of the dialog, there is a question mark icon on the left and an "OK" button on the right. In the background, the main interface is visible, showing a "Profile:" dropdown menu set to "Upload and Decide Later", a "Title:" text input field, a "Description:" text area, a microphone icon with "Auto" text, a volume slider, and two large circular buttons labeled "test" (blue) and "rec" (red). At the bottom of the interface, a status bar shows a green checkmark icon and the text "Connected to: <https://ca-camtasia.ieee.org/relay>".

Guest 150120 (Guest)

Presentation Complete

The presentation was submitted for upload to the server.

If you are currently **online**, the presentation will begin to upload immediately.

If you are **offline**, your presentation is now stored on your computer and will automatically begin to upload the next time your computer is online.

?

OK

Profile:  
Upload and Decide Later

[What is "Upload and Decide Later"?](#)

Title:

Description:

Auto

test rec

Connected to: <https://ca-camtasia.ieee.org/relay>



# 13. Presentation Published on server

**Subject:** Presentation Published: Test demo1  
**From:** IEEE CS Camtasia (camtasia@computer.org)  
**To:** johnwalz@ameritech.net;  
**Date:** Saturday, August 23, 2014 3:45 PM

A presentation recorded at 8/23/2014 1:35:10 PM is ready for sharing and viewing.

Title: Test demo1  
Description: Test demo1  
Duration: 0:00:13

Type	Size	Link
MP4 (Original Size)	425 KB	<a href="#">View...</a>

Automatic notification by **Camtasia Relay**  
Send TechSmith your [feedback](#).

# Content Distribution

- ▶ Screencast.com from TechSmith  Screencast.com  
<http://www.techsmith.com/screencastcom.html>
  - public access or three levels of privacy

# Camtasia Demo

---

- ▶ Make a great recording: Select, Start, Pause
- ▶ <http://www.screencast.com/t/1zj7SE7j8RjE> (6:52)

# 8. Lab experiences

- ❖ Install & run
- ❖ Audio connection
- ❖ Make a Test Recording
- ❖ Make a short Recording,  
whose title has your email
- ❖ Preview the Recording
- ❖ Submit the Recording

# 9. Optional Post-editing

# 10. Q&A → Commitment

# 10. Q&A → Commitment



# 10. Q&A → Commitment

- Commitment
  - Audio purchase
  - Train Chapter officers
  - Request Software License
  - Software downloads on Chapter and Speakers' laptops
  - Manage Chapter recordings
  - Publicize Chapter recordings
  - Share best practices & best presenters



# 11. Backup

# Chapter Recordings & Distribution Configurations

- ▣ Audience
- ▣ Audio
- ▣ Laptop
- ▣ Presenter
- ▣ Manual / Automatic work flow

# Audience Configurations

# attendees	Presenter style	Audio configuration
up to 10	podium	wireless mic
up to 30	podium, walk around	wireless mic
over 30	podium, walk around	wireless mic & handheld

# Audio Configurations

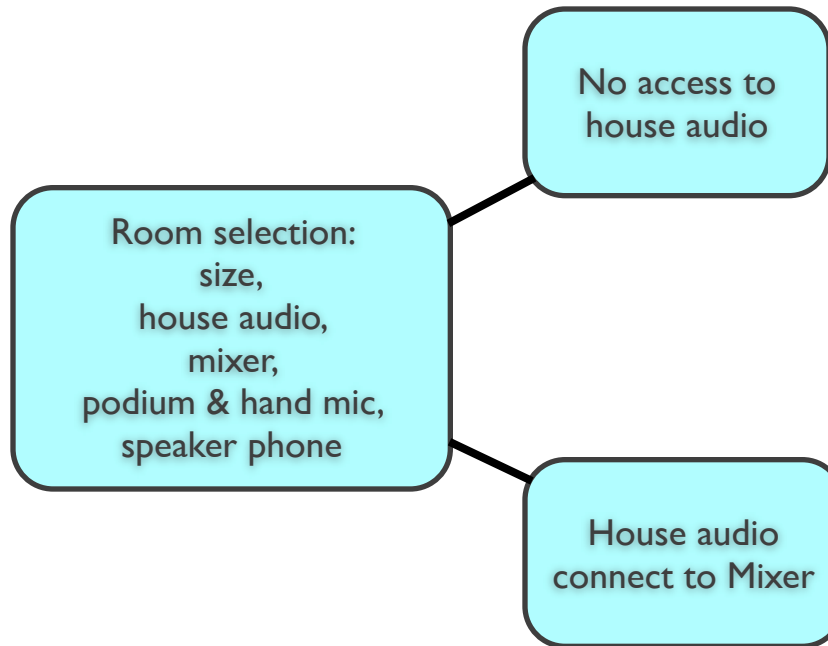

# Laptop Configuration: IEEE's or Presenter's

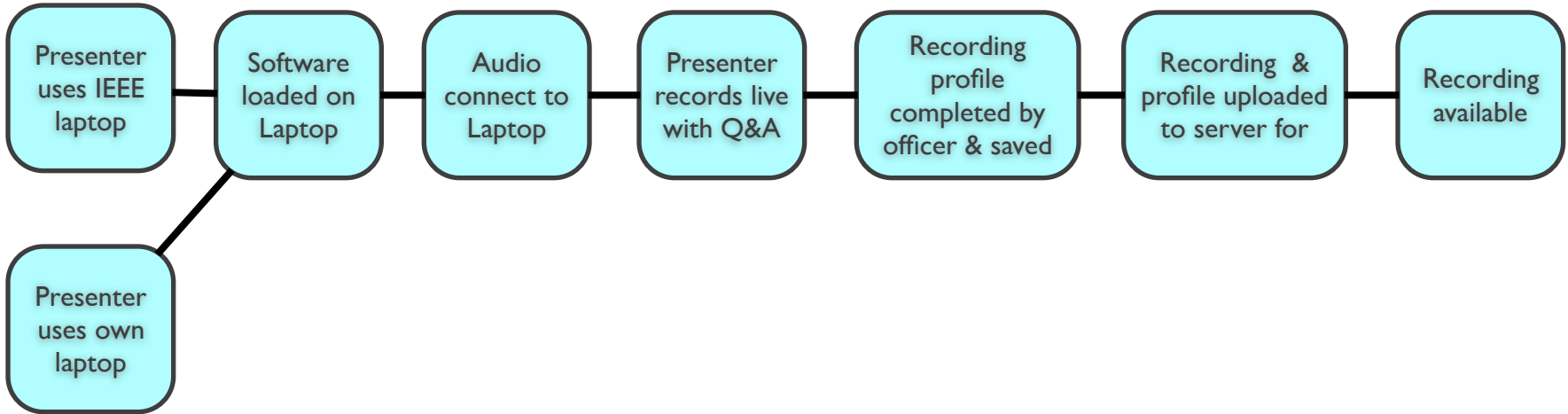

# Presenter Configuration: local / remote

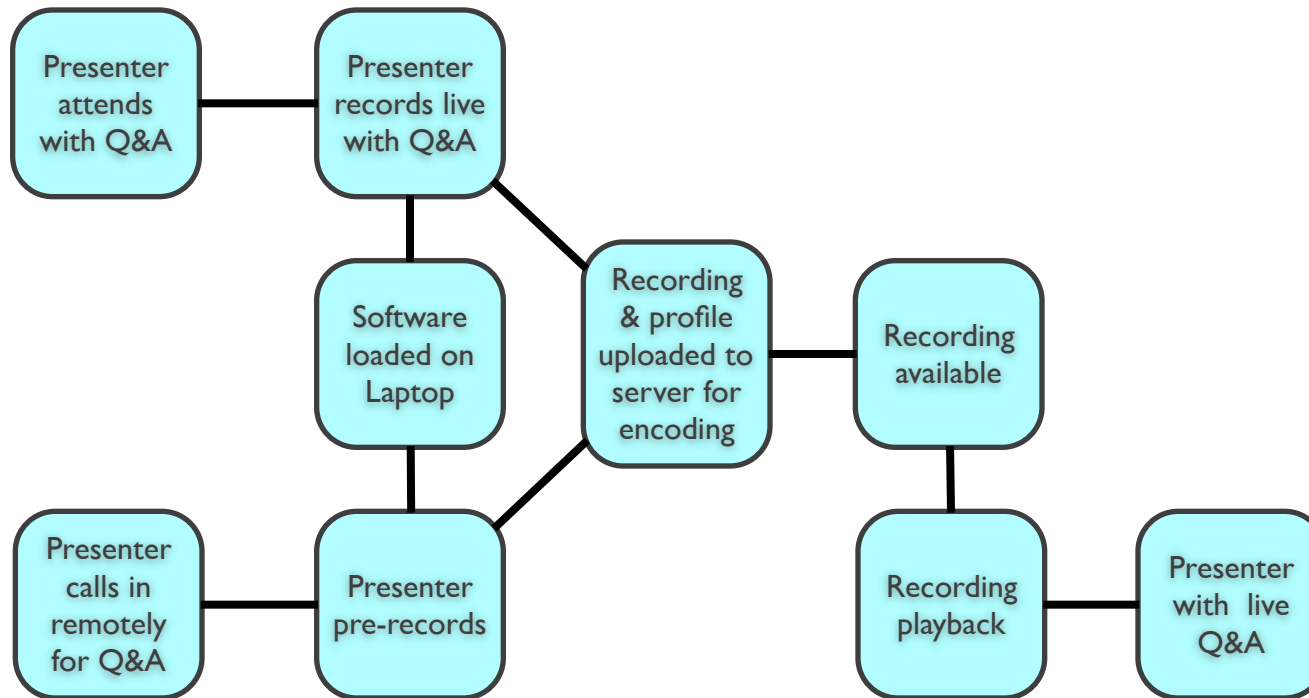

# Manual / Automatic work flow

	Manual	Automatic
Distribution site	Screencast.com	computer.org
Presentation website	Manual on Chapter web	Automatic on computer.org
Presentations Catalog	Manual on Chapter web	Automatic on computer.org
Access	Open	IEEE login
Non-IEEE	free	small mtc. fee
Search	?	Yes on metadata
Social media	?	Yes
Analytics	?	Yes
Date	Now	Feb/March

# Chapter Recordings & Distribution Flow

