

How Bad is Bad?

Cavity Signal Injection and Mitigation

Steve Weir
IPBLOX, LLC
sweir@ipblox.com



Property Rights Disclosure

“PROPERTY OF IPBLOX, LLC”

Information contained in this document is not to be reproduced in any form without permission of IPBLOX, LLC. Any information in this document is proprietary and may not be used or disclosed without the express permission of IPBLOX, LLC.

“CONFIDENTIAL PROPERTY OF IPBLOX LLC”

This document includes valuable trade secrets. Unauthorized disclosure of use of this document may violate the Uniform Trade Secrets Act.



Signals and Cavities

- Almost all signal energy travels through dielectrics.
- Signal traces and return planes almost completely reflect E/M energy, binding it into a limited dielectric volume.
- A signal trace that follows one contiguous return plane sets up TEM propagation between the trace and the plane.



Simple Microstrip Signal Transmission

- Signal is bound by the signal trace and a solid return plane.

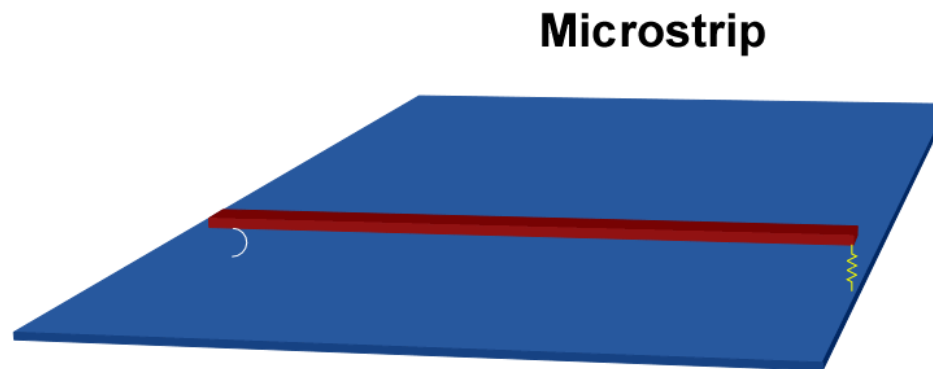

Simple Microstrip Signal Transmission

TRAVERSING A CAVITY

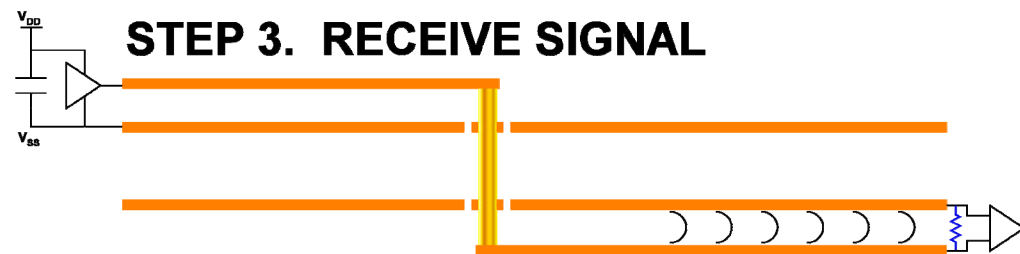
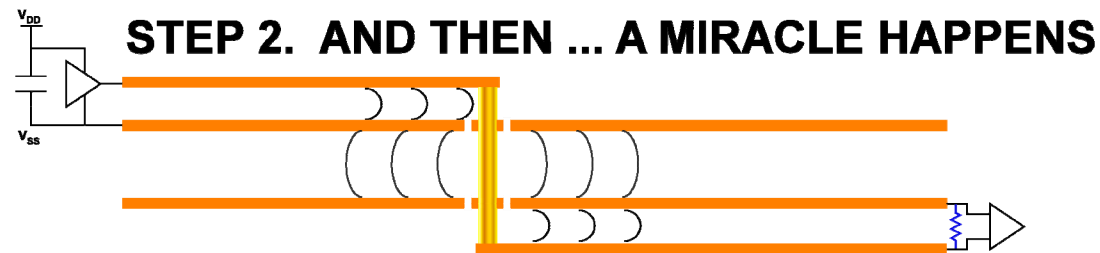
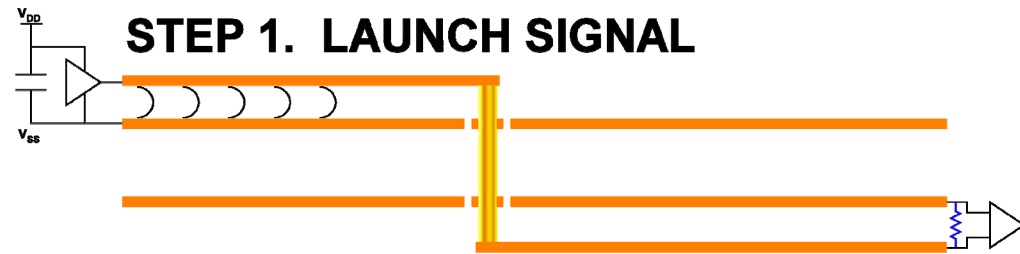

About That Miracle...

- Virtually all signal energy passes through dielectric.
 - Metal almost completely reflects the E/M energy.
- The energy disperses in the X-Y plane until:
 - Stitch vias, or bypass capacitor structures reflect it.

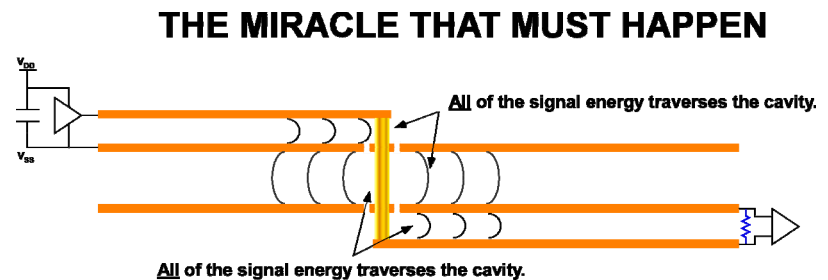

Cavity Apertures

- Metal almost completely reflects E/M energy.
- Energy passes through the Z axis through apertures.
 - A completely unperforated plane would form one side of an ideal Faraday shield
- Metal in proximity reflects energy, guiding most of it.

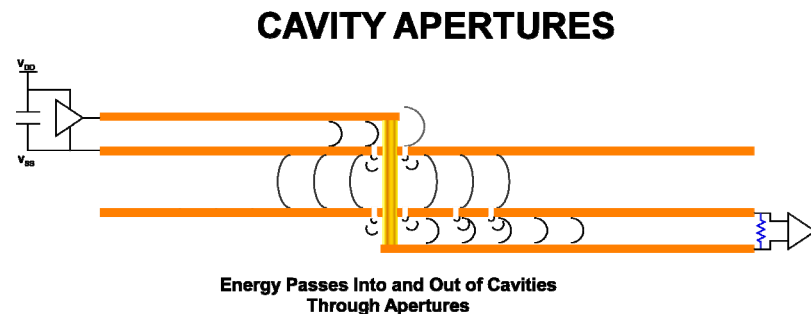

Stitching Vias, Bypass Caps

- Stitch vias and bypass capacitors form reflection boundaries.
- Effective inductance of stitching via is limited by cavity thickness.
- Effective inductance of bypass cap includes capacitor and via length from the cavity wall to the capacitor mount.

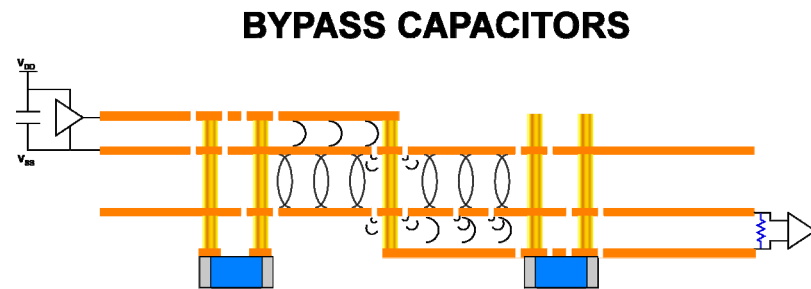
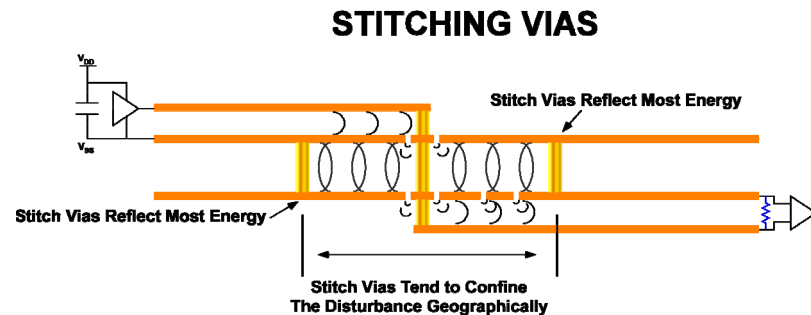

Cavity Injection Test Set-Up

- Pulse generator with moderately fast T_R/T_F , comparable to DDR2, DDR3
- 6dB wideband > 18GHz power divider
- DUT fixture
- 2GHz Scope
- Vary input power w/ attenuator between pulse generator and the power divider

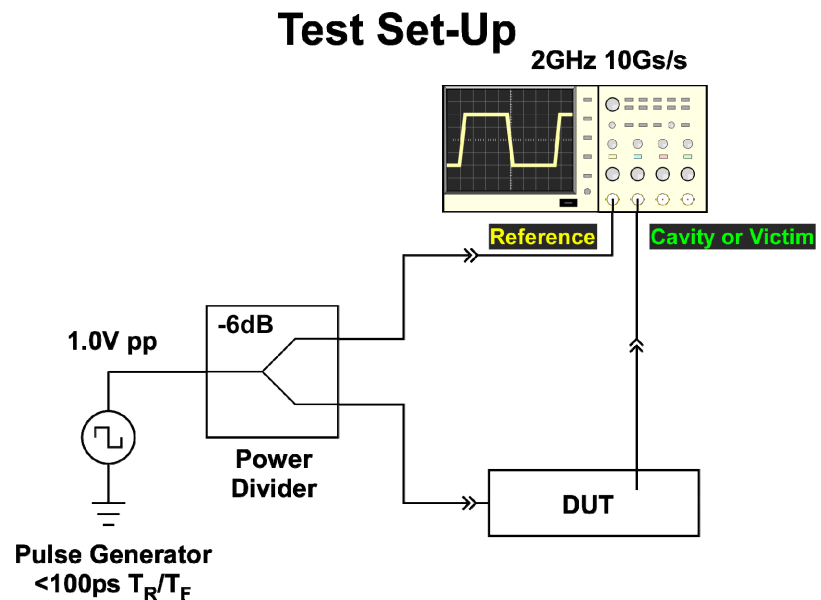

Cavity Injection Test Set-Up

- DUT Fixture:
- Trace 1
 - Layer 4, crosses split in Layer 3
- Trace 2
 - Contiguous over solid Layer 3
- Trace 3
 - Contiguous over solid Layer 2
- Trace 4
 - 2" Layer 1
 - 2" Layer 4
 - 2" Layer 1
- Three cavity probes
- Locations for bypass and stitching capacitors.

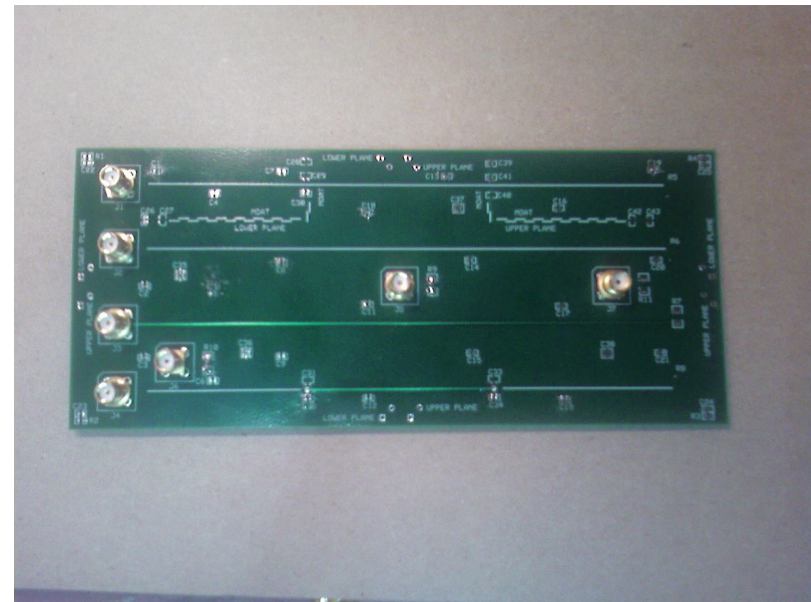

Signal Archetypes

- 1V signal from pulse generator
 - 0.5V leading edges into DUT and REF monitor ports
- Open DUT traces reflect 0.5V edge
- 6dB attenuator cuts DUT reflection voltage seen by REF in half.

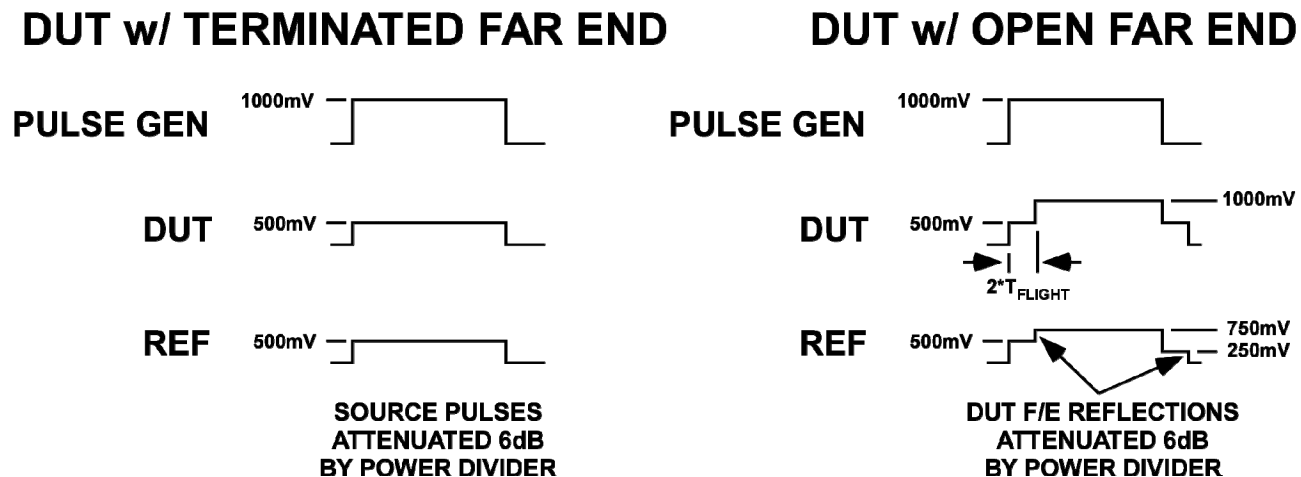

Linear Additive Power

Cavity Disturbance No Bypass, Center Cavity Probe
2" Layer 1 -> 2" Layer 4 -> 2" Layer 1 Microstrip Aggressor

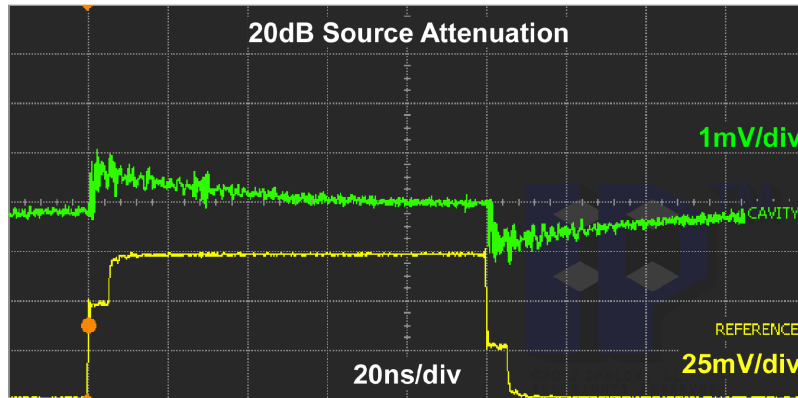

Cavity Disturbance No Bypass, Center Cavity Probe
2" Layer 1 -> 2" Layer 4 -> 2" Layer 1 Microstrip Aggressor

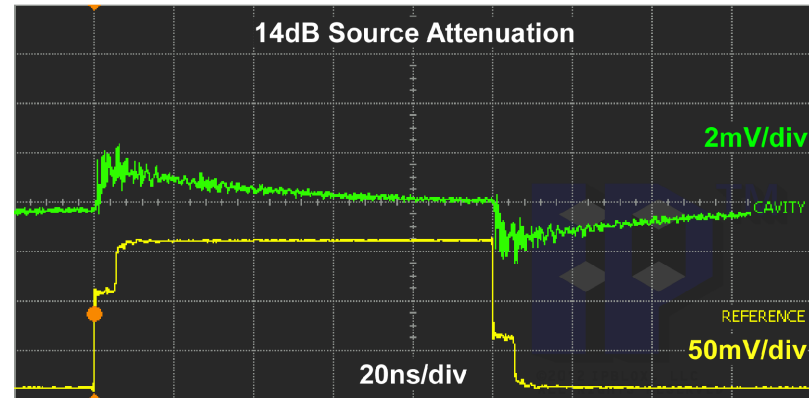

Cavity Disturbance No Bypass, Center Cavity Probe
2" Layer 1 -> 2" Layer 4 -> 2" Layer 1 Microstrip Aggressor

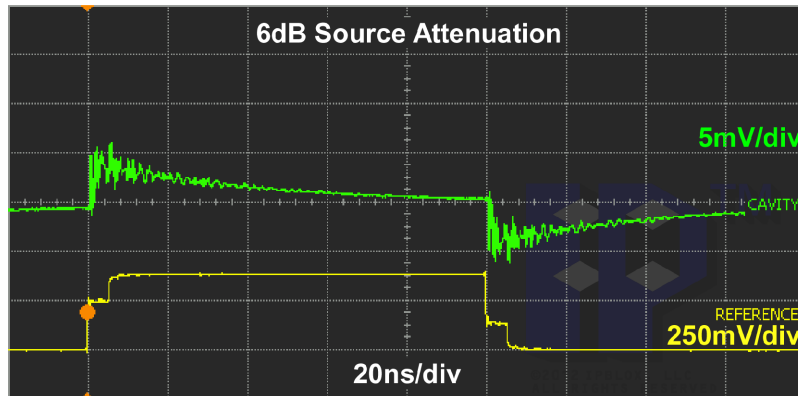

Cavity Disturbance No Bypass, Center Cavity Probe
2" Layer 1 -> 2" Layer 4 -> 2" Layer 1 Microstrip Aggressor

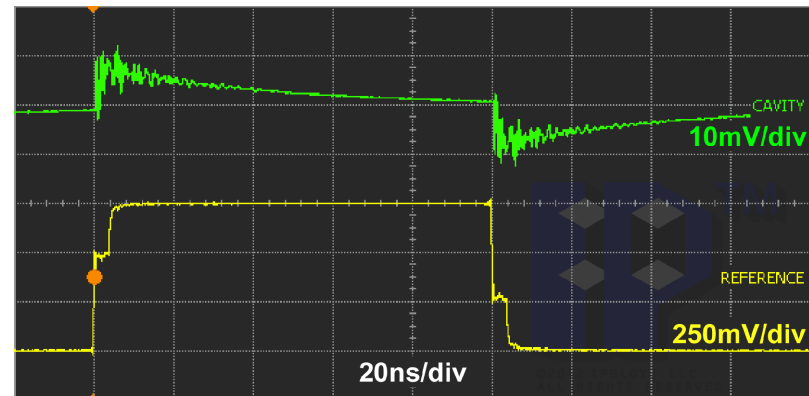

Linear Additive Power

- Cavity disturbance voltage linearly proportional to aggressor $\sqrt{\text{power}}$
 - 100X change in power = 10X linear change in voltage
- What about victim signals?

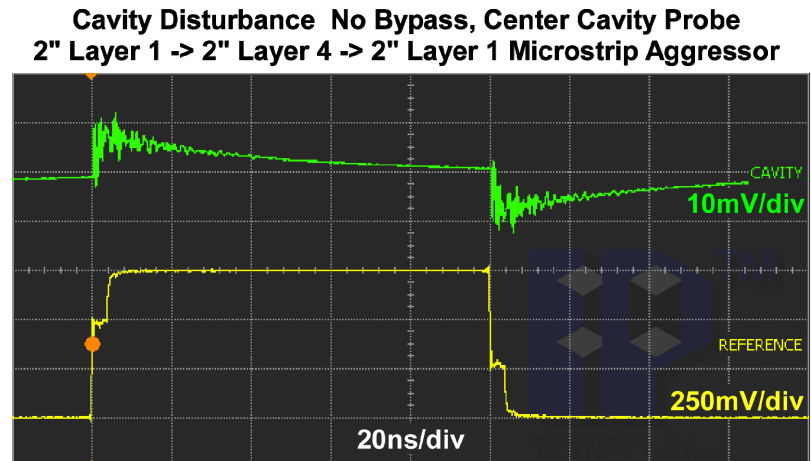
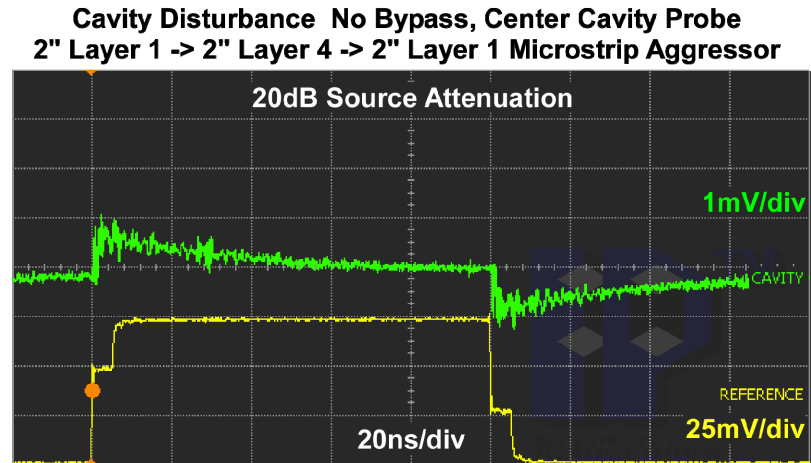

Victim Crosstalk Power

- Cavity disturbance voltage linearly proportional to aggressor $\sqrt{\text{power}}$
 - Mimics cavity noise scaling

Cavity Disturbance No Bypass, Plane Cross Victim
2" Layer 1 -> 2" Layer 4 -> 2" Layer 1 Microstrip Aggressor

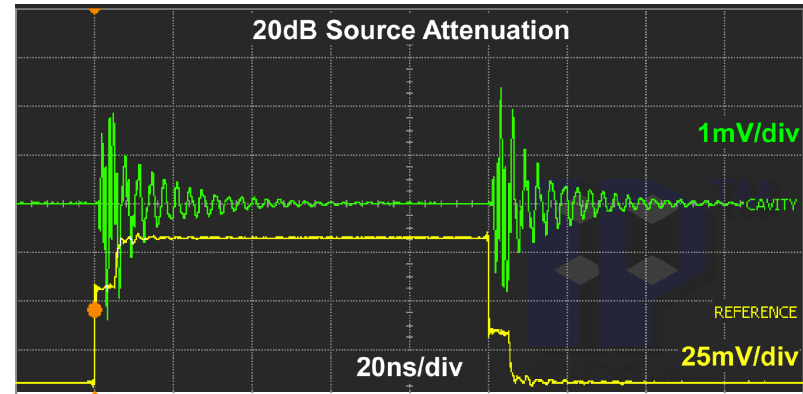

Cavity Disturbance No Bypass, Plane Cross Victim
2" Layer 1 -> 2" Layer 4 -> 2" Layer 1 Microstrip Aggressor

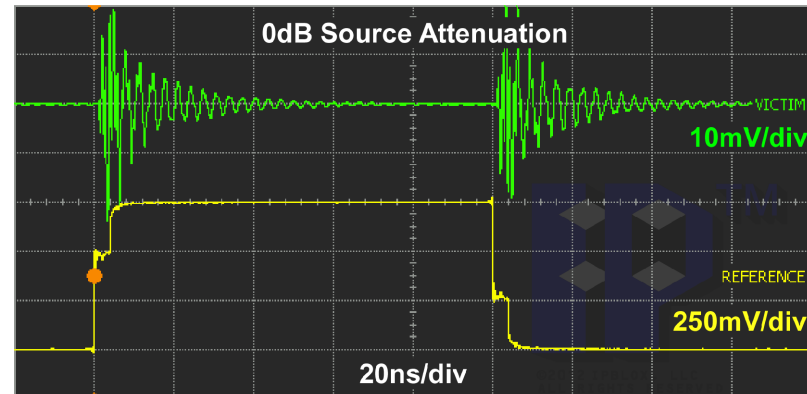

Key Points

- When a signal traverses any cavity, the entire signal energy is impressed across the local impedance of the cavity.
- Noise power adds linearly.
- Ohm's Law still applies: $V_{\text{NOISE}} = \sqrt{P_{\text{NOISE}} * Z}$
- Cross-talk coupled onto other signals that traverse / couple to the cavity also scales linearly in power.



Mitigation Strategies

- Decrease injected power
 - Don't traverse the cavity
 - How effective are stitching capacitors?
- Decrease cavity impedance
 - Thinner dielectric
 - Loaded dielectrics
 - Cavities with one voltage: via stitch density
 - Power cavities: bypass capacitor density
 - Tame resonances.



Stitch Via Effectiveness

- Cavity planes joined by only one via exhibit stiff resonances at low frequencies.
- Increasing the number of tie points divides the geometry, pushing resonant frequency up and overall noise down.

Cavity Disturbance Single 0 Ohm Resistor Plane to Plane
2" Layer 1 -> 2" Layer 4 -> 2" Layer 1 Microstrip



Cavity Disturbance Four 0 Ohm Resistor Plane to Plane
2" Layer 1 -> 2" Layer 4 -> 2" Layer 1 Microstrip

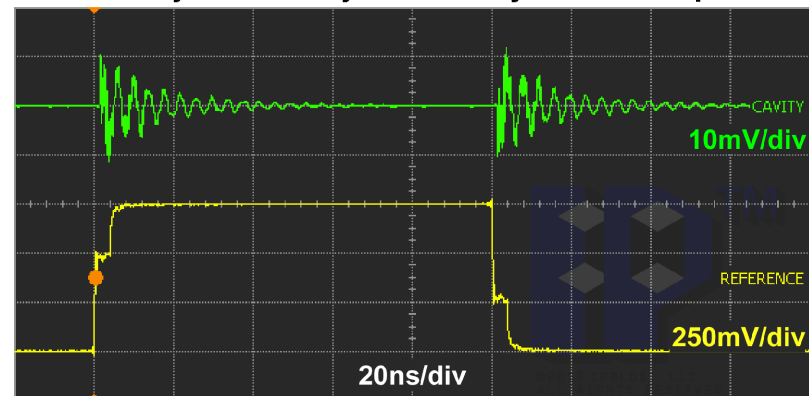

Signal Stitch Capacitor Effectiveness

- Effectively another bypass cap
 - Idea is to minimize impact of cavity spreading L
- Depends on signal spectra and attached inductance to the traversed cavity.
 - Typical 0402 500pH + 20pH / mil to cavity center
 - 1.0 – 1.2nH to cavity in center of 0.062” PCB
 - 100ps $T_R = 3.5\text{GHz } F_{\text{KNEE}}$
 - 1nH = 22 Ohms @ 3.5GHz



Stitch Capacitor Effectiveness

- Adding a stitch capacitor to each transition decreased victim pp noise by 38%.
 - Effectiveness limited due to capacitor mounted inductance and signal spectrum

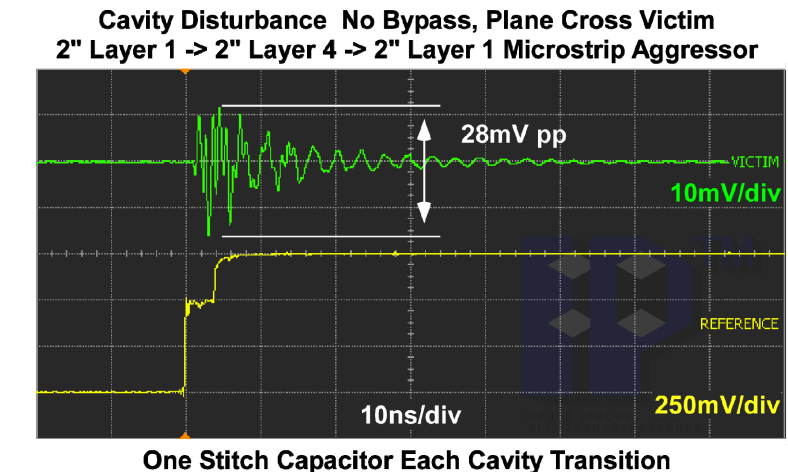
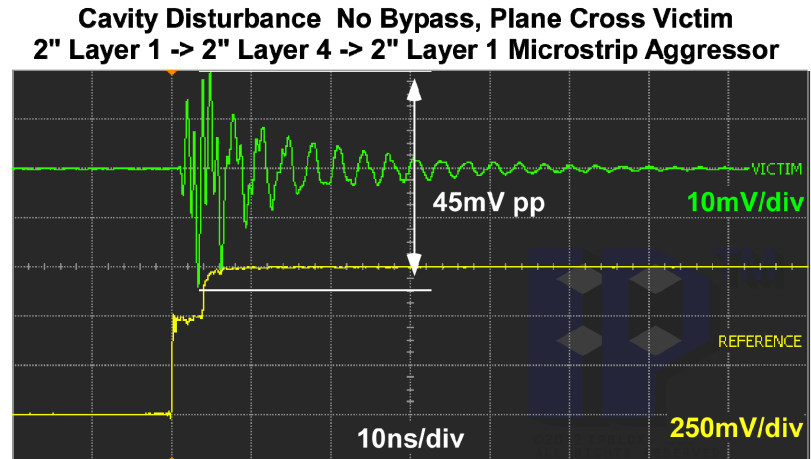

Bypass Network Effectiveness

- Bypass capacitors provide inductively limited shunt paths through a power cavity.
- Resonance forms at cross-over frequency between discrete network distributed L and cavity C.
- Frequency proportional to $1/\sqrt{L}$
 - For like package and attachment caps frequency is proportional to \sqrt{n} , where n is the number of capacitors
 - For fast T_R signals, unless the PCB is turned black with caps, the cavity Z sets the initial impulse amplitude.



Bypass Network

- Bypass network provides low and medium frequency shunt.
- HF shunt current is drawn from the cavity itself.
- Bypass network resistive near F_{CO}

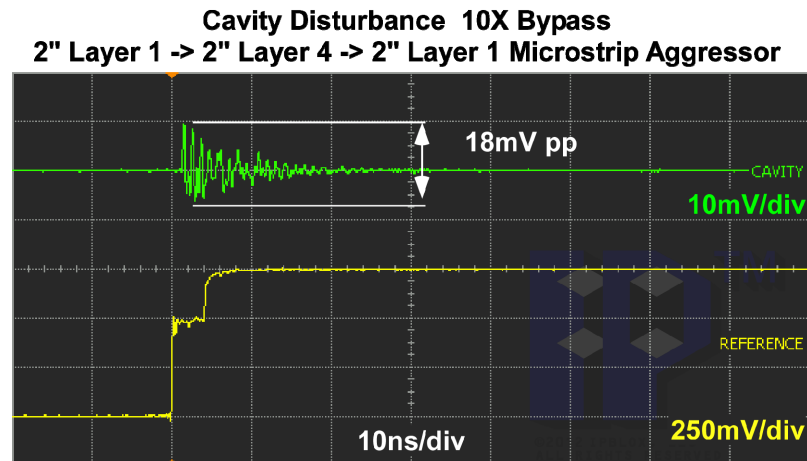
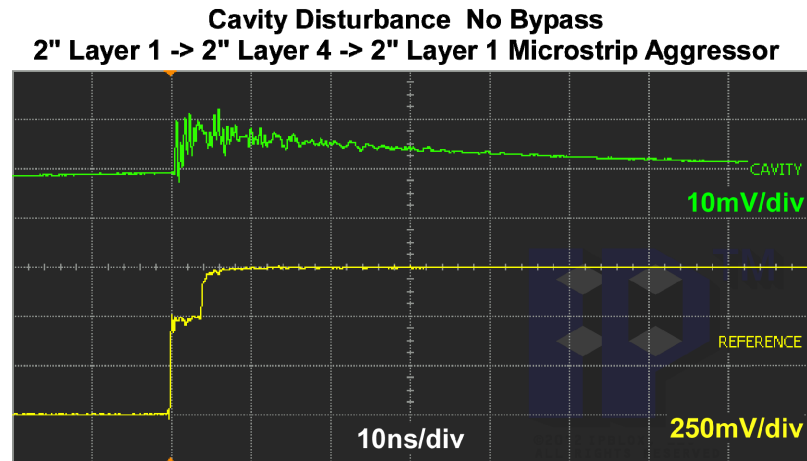

Reduce Excitation Power

- Where a choice of termination is available, such as which types of signals traverse a cavity, double terminations cut injected power by half versus series terminations alone.

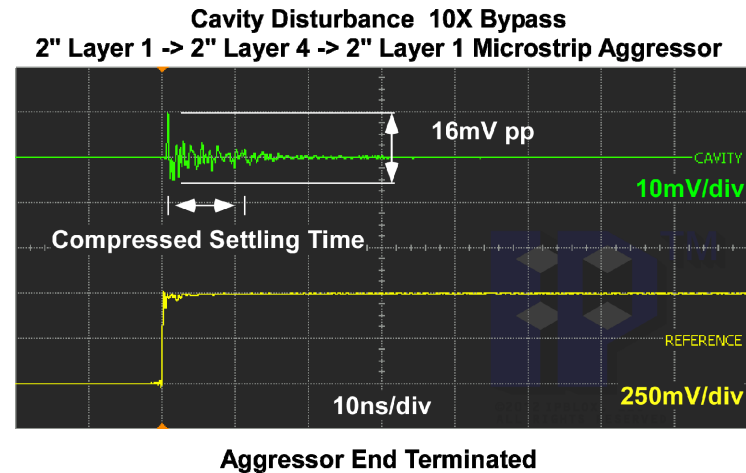
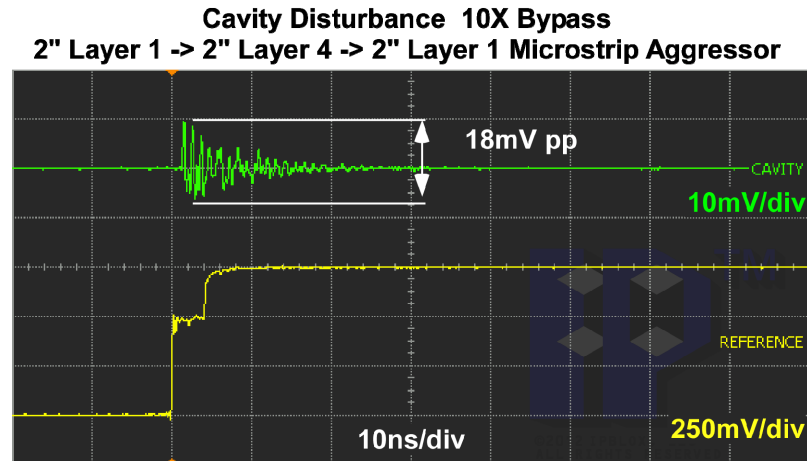

Reduce Excitation Power

- Reduced excitation plus careful bypass settles quickly.
- Initial impulse still dominated by the cavity only response.

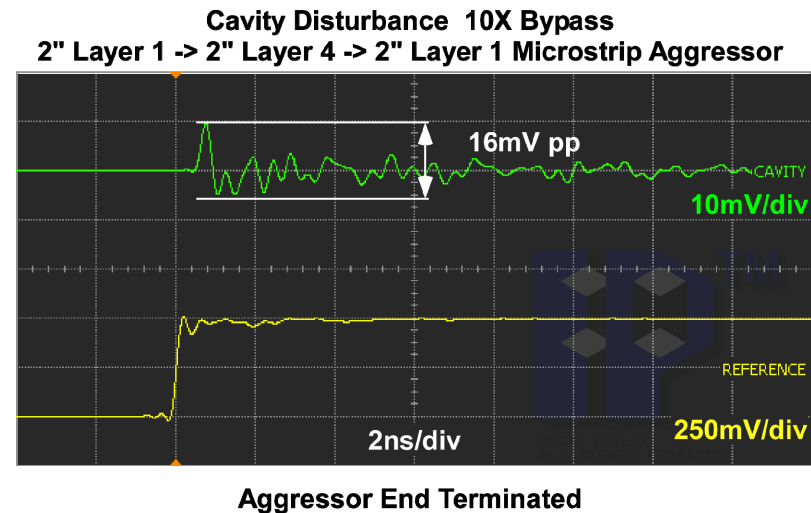

Reduce Coupling Efficiency

- Rx / Tx reciprocity
 - Reduce victim coupling w/ stitch cap(s).

Cavity Disturbance 10X Bypass, Plane Cross Victim
2" Layer 1 -> 2" Layer 4 -> 2" Layer 1 Microstrip Aggressor

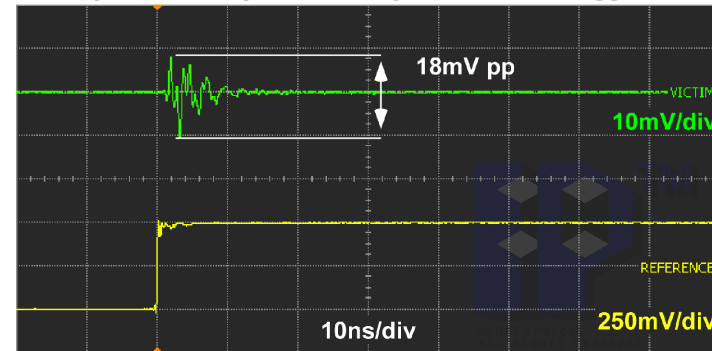

Aggressor Terminated
One Stitch Capacitor Each Cavity Transition

Cavity Disturbance No Bypass, Plane Cross Victim
2" Layer 1 -> 2" Layer 4 -> 2" Layer 1 Microstrip Aggressor

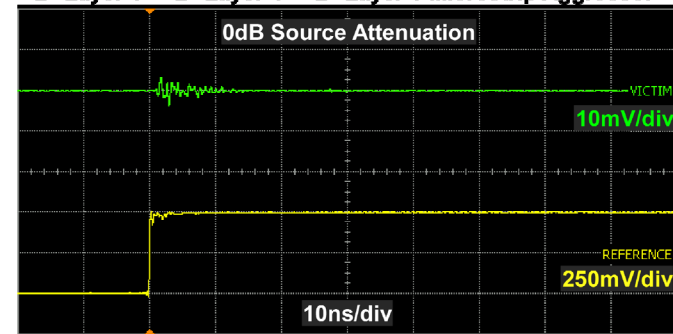

Terminated Aggressor
Plane Stitch @ Both Traverses
Slot Cross Cap @ Victim



Summary

- I/O signals that traverse cavities inject the entire signal energy into the cavity.
- Injected power adds linearly, while noise voltage increases as the square root of the number of signals.
 - A few signals can be OK where many can be disastrous.
- The easiest mitigation when available is to only traverse cavities with dense stitching vias.
- Traversing cavities tied with capacitors induces noise that depends on:
 - Cavity thickness, ϵ_r , bypass complement, signal spectrum, and mounted capacitor inductance, and how well the bypass network is designed to avoid a large cross-over resonance with the cavity.
 - Thin cavities exhibit low HF impedance



How To Contact Us?

IPBLOX, LLC

150 N. Center St. #211

Reno, NV 89501

www.ipblox.com

eng@ipblox.com

(866) 675-4630 Voice

(707) 780-1951 Fax

